

In a time during a recovery period in my life I needed to focus on something technical and not on my current issues and so I chose this and other topics to explore. Growing up with analog audio and video and the circuits used for them I've always appreciated the simplicity of well designed circuits using minimal parts and getting great performance out of them. A lost art much like early computer programming which required very efficient code to maximize performance and features, and so it is for analog circuits too, using the fewest parts to obtain the best performance. Well designed analog circuits will usually draw less power than their digital counterparts and are usually repairable, unlike today's electronic products that are thrown away when broken and end up in landfills. And so during this period the focus is on the various analog TV systems that have been used worldwide.

New Analog TV in a Digital World

In the U.S. NTSC-M was the first widespread Color TV system adopted and helped to spawn the other two versions, PAL & SÉCAM. Both these designs addressed the 'Never The Same Color' hue tracking issues of NTSC in different ways, but also introduced issues that NTSC doesn't have. Besides the hue tracking issues NTSC suffered from fuzzy images caused by insufficient video bandwidth for the number of scan lines used, i.e. non-square pixels. PAL & SÉCAM solved this by increasing the channel space by 33 $\frac{1}{3}$ % and lowering the frame rate by 16 $\frac{2}{3}$ %. The frame rate was not chosen to be the same as NTSC's choice of 30FPS which had to do with 60Hz AC line frequency but by the line frequency chosen in Europe of 50Hz for 25FPS, 60 not being a metric number. If 24FPS was chosen film to video transfer would have been seamless without the audio speed increase. For a '**System Éssentially Contrary to American Method**' it does have better signal integrity over long transmission lines and greater over the air distances. Both PAL & SÉCAM also have their shortcomings too. SÉCAM does not have the ability to mix/fade two signals together in composite mode and PAL's modifications to NTSC, while solving the hue drifting issues, created a more complex signal which made digital signal processing much more complex.

Today digital TV can offer sharp high resolution and noise free pictures if signal conditions are good but below the signal threshold there is no signal at all. In most areas where digital TV replaced NTSC the carrier modulation method used is 8VSB which seems to be less robust in some environments versus COFDM which is used by the rest of the world. Living about 7 miles from most of the TV transmitters in my area signal dropouts should not occur but they frequently do. At least with analog TV poor picture quality will occur but is still watchable unlike the perfect signal / no signal characteristics of digital TV. Local broadcasters now need to rely more on cable, satellite, and internet to get their signal to the local viewers. This has left some who do not have cable/satellite/internet service to go without a signal which means loss of viewers for local broadcasters. Multiple channels within the same channel space are possible but with the variable quality modes available with digital compression quality cheating is rampant and rife with mosquito noise, posterization, and mega pixel blocks. Ten signals crammed into one channel space offering picture quality worse than NTSC in some cases is not my idea of 'Digital is Better than Analog'. What is the benefit of a multitude of channels with crummy programming and poor picture quality that few can watch. Many have left broadcast TV for other delivery methods like YouTube, Amazon, NetFlix, Hulu, Vudu, and other streaming services.

With these issues I would like to think that there is still a place for an analog TV signal that would increase coverage area and would not allow severe quality cheating through high levels of digital compression. It may be less spectrum efficient but a top quality digital TV signal can use up to a whole channel space for maximum quality if desired especially if it's 4K and/or 3D. A trade off of lower spectrum efficiency for greater coverage area and signal integrity can be beneficial. Speaking of Ultra HD your eye can't see 4K. Given the eye's resolving power there is a diminishing return on perceived clarity that is possible. A 2MP HD TV image is more than enough for a large screen TV at a normal viewing distance for casual viewing. I guess 4K Ultra HD is necessary if one likes to sit 5' from a 60" screen and be constantly over stimulated. Many viewers watch TV on very small screens through the internet like smart phones, tablets, and computers while many of the older CRTs are larger than this. CRT technology is very mature, reliable, and repairable with sets easily lasting 20 years or more drawing no more power than modern LCD panels.

With this in mind an updated analog TV format building on the benefits of some of the three original versions and fine tuned with newer innovations can produce a format that is highly optimized for today's digital processing but still could be received on a conventionally designed analog TV. One that is a bit more spectrum efficient and offers better coverage area could still be of use especially in difficult environments that would cause digital signal dropout. Having an analog format for a fallback as a part of a digital TV standard could offer broadcasters greater coverage area in certain environments. Any signal is usually better than NO SIGNAL. Retro is in. Vinyl records have made a comeback so why not analog TV with improved pictures using CRTs. LCD screens, while having a large and sharp picture, lack in contrast, vibrant colors and just look, well, FLAT ;-). Picture's **Always** **Lovely** with the vibrant colors of glowing phosphors. Only the expensive OLED flat screens offer this level of contrast and color fidelity once enjoyed with CRTs.

It is the goal of this document to share this exercise in defining various analog TV configurations and hybrid digital processing versions with the open source community. Whether or not this will result in a new analog format being created and used at least it is here for a history lesson and education. On the chance that there may be new and creative ideas introduced here that are of some value a viewing license wrapper is used that is intended to prohibit proprietary interests from claiming sole ownership and/or restricting free use of said ideas. The usual path in protecting ideas are patents, which are costly to obtain within a broken system and in the words of Arthur C. Clark, "A License to be Sued". This is the spirit of this wrapper with the intent in which it has been written. IANAL so the letter of the wrapper may not be perfect.

This document is written in a journal style as new ideas come to mind, put together and then written down. At times when bored or had a mental block in my brainstorming I turned to embellishing what had already been written to help spark my imagination so things do get a bit colorful at times, so to speak. In some cases it's overboard i.e. **Chroma** with its rainbow of colors but hopefully it will help with memory mnemonics. After writing most of what could be said a summary of claims will precede the body of the journal.



Viewer License Agreement

You Must Read This License Agreement Before Proceeding.

This Scroll Wrap License is the Equivalent of a Shrink Wrap ⇒ Click License,
A Non-Disclosure Agreement that Creates a “Cone of Silence”.

By viewing this Document you **Permanently Release All Rights** that would allow you to restrict the **Royalty Free Use** by anyone implementing in Hardware, Software and/or other Methods in whole or in part what is Defined and Originates here in this Document. This Agreement particularly **Enjoins** the viewer from: Filing any **Patents** (À La Submarine?) on said **Technology & Claims** and/or the use of any **Restrictive Instrument** that prevents anyone from using said **Technology & Claims** Royalty Free and without any Restrictions. This also applies to registering any **Trademarks** including but not limited to those being marked with “™” that Originate within this Document. **Trademarks** and **Intellectual Property** that Originate here belong to the **Author** of this Document unless otherwise noted. Transferring said **Technology** and/or **Claims** defined here without this Agreement to another Entity for the purpose of but not limited to allowing that Entity to circumvent this Agreement is Forbidden and will NOT release the Entity or the Transfer-er from Liability. Failure to Comply with this Agreement is **NOT** an Option if access to this content is desired. This Document contains **Technology & Claims** that are a **Trade Secret: Proprietary & Confidential** and cannot be transferred to another Entity without that Entity agreeing to this “Non-Disclosure Cone of Silence” **V.L.A.** Wrapper. Combining **Other Technology** with said **Technology** and/or **Claims** by the Viewer is an acknowledgment that [s]he is automatically placing **Other Technology** under the Licenses listed below making this License Self-Enforcing under an agreement of Confidentiality protected by this Wrapper.

The contents of/and this Document are released under the following licenses so long as this Agreement remains attached to any and all files, papers, etc... that contain any said **Technology** and/or **Claims**. Any Hardware manufactured with said **Technology** and/or **Claims** must contain a brief message, e.g. “**V.L.A.** This Hardware contains Technology and/or Claims that are Licensed for Unrestricted and Royalty Free Use. Any knowledge gained by viewing this hardware design may not be used to file any patents, employ restrictive licensing, or interfere with the manufacture, sale and use of this hardware”.

Software only: [GNU General Public License 3.0 \(GPL\)](#)

Hardware (w/ || w/o software): Tucson Arizona Packet Radio TAPR [PDF](#) [ODT](#) [TXT](#)

This Document is licensed under [Creative Commons](#) so long as this V.L.A. remains attached to the contents of this document in whole or in part. It may be re-distributed and hosted anywhere.

Open Source ([CC BY 4.0](#)), Proprietary ([CC BY-ND 4.0](#))

Scrolling past this page is **The Point of No Return** and Acknowledges that You have Agreed to the Terms above. If you are Unable or Unwilling to Agree to these Terms then Close this Document.

Summary of Claims

Trade Secret:
Proprietary
& Confidential

TruColor™, Specification originally published in 2012 – A Luma/Chroma matrix with **RGB** weighting that produces an even stair step Luma signal when the 'Wh**Y**C**Cy**Gr**Mg**R**d**B**Bk**' color bars are generated. When the **U** & **V** Chroma signal levels are adjusted and combined in quadrature they produce an equilateral hexagon on the Cartesian grid (vector scope), optimizing Chroma signal levels. The **I** & **Q** channels are positioned $\pm 45^\circ$ away from the **U** & **V** channels. The hue of TruColor's **I** channel is $< 2\frac{1}{5}^\circ$ away from NTSC's **I** channel hue of **#FC6600** and TruColor's **Q** channel's hue of **#E700FB** is $< 4\frac{1}{8}^\circ$ away from the **Green-Magenta** axis. This **YUV** (4:2:2) weighting and matrixing scheme could also be used for photographic still image files or digitized motion picture image files for which a file format could be optimized for the digital storage of these analog TV systems described here. This **RGB** weighting provides a better orthochromatic **B** & **W** visual representation to the eye than the panchromatic weighting used in most image file formats while also offering a symmetrical color wheel with the axes spaced 60° apart and of equal level, the same as the panchromatic weighted images. This lends its self to very similar **YUV** color processing used in the panchromatic image formats.

Chroma Rotary Phase™ (CRP™) – Simulates PAL's on screen Chroma rotation (shift) while elegantly re-engineering it using a 3:1 interlace without the consequences of the objectionable on screen dot pattern. PAL broke NTSC's **2** frame repeat Chroma dot pattern by modifying its $180^\circ \frac{1}{2}$ cycle/line chroma phase offset to $270^\circ \frac{3}{4}$ cycle. PAL partially resolved this issue by adding **1** frame rate of cycles to the Chroma sub-carrier frequency creating a 180° phase inversion of the Chroma signal at the start of a new field to break up the dot pattern but still has a **4** frame repeat. With NTSC using an odd number of scan lines per frame and the $180^\circ \frac{1}{2}$ cycle/line chroma phase offset naturally produces this effect. When used with TruColor™ the rotating Chroma signal is spectrally balanced and the equilateral hexagon provides better color correction when Chroma phase variance occurs during marginal signal conditions. Vector [Phase] Rotation can be realized using two methods. **U** & **V** signals are both electrically rotated 90° per line in opposite directions or **U** & **V** are inverted 180° every two lines at the H/4 rate where **U** & **V** switching is offset by one line from each other. In the direct **U** & **V** 90° rotation scheme this indirectly causes **I** & **Q** to invert 180° every two lines at the H/4 rate and are offset by one line from each other. Likewise in the direct **U** & **V** 180° inversion this indirectly causes **I** & **Q** to rotate 90° per line in opposite directions. With an **I** & **Q** dual bandwidth setup where the two **I** & **Q** Chroma channels have different resolutions they too can be modulated using the same methods. In all schemes the on screen vector rotation (shift) is in the opposite direction of its electrical rotation as a result of the $\frac{1}{2}$ cycle/line offset. With the $\frac{1}{2}$ cycle/line offset and the H/4 modulation this places the sidebands at the $\pm \frac{1}{4}$ positions as it is in PAL in relation to the $\frac{1}{2}$ position. In PAL the $\frac{3}{4}$ position for **U** is realized with the $\frac{3}{4}$ cycle/line offset of the Chroma sub-carrier period in relation to the horizontal period and **V**'s sub-modulated

sidebands at $\frac{1}{4}$ positioning is a result of the H/2 switching modulation. The $\frac{3}{4}$ cycle/line offset causes both **U** & **V** to rotate (shift) on screen in the same direction but the H/2 switching of **V** reverses its on screen rotation (shift).

3:1 Interlace, 72i/24p — Using a 3:1 interlace with this faster field rate reduces flicker and with the frame rate set to conventional motion picture stock eliminates the need for Telecine or 3:2 pull down in NTSC or increasing the frame rate by $4\frac{1}{6}\%$ to 25FPS for PAL. Using a 3:1 interlace with the 4 phase state **CRP**[™] (or PAL for that matter) realizes the simple diagonal chroma dot pattern very similar to NTSC. To achieve a natural 2 frame Chroma dot repeat rate the number of lines in 2 frames must be evenly divisible by 4 with an odd quotient but not by 8, which would result in a $\frac{1}{2}$ line remainder. To achieve the 3:1 interlace a field must end with either $\frac{1}{3}$ or $\frac{2}{3}$ line when the number of lines per frame is divided by 3. It is also desirable to have the number of lines per frame of active picture area be a factor of 16. With these requirements lines per active picture frame increment by 48, e.g. 384, 432, 480, 528, 576... When using a $\frac{2}{3}$ line offset the Chroma dot crawl moves up the screen as it does with NTSC. For a given color depending on the phase of the Chroma when the diagonal dot crawl pattern is symmetrical along a vertical line it closely resembles NTSC's dot pattern. When the Chroma phase is $\pm 45^\circ$ off from this the diagonal dot pattern angle could be shifted by up to $\pm 15^\circ$ from symmetrical. For CRTs if a 3:1 interlace motion pattern is visible greater phosphor persistence could minimize this without creating tracers during fast motion.

36FPS & 3:1 Interlace — If this faster motion picture rate of 36FPS is used for filming it is possible to easily convert this to a 72i/24p format by using 2 of the 3 scan lines to represent a frame for a quasi 2:1 interlace 72i/36p at $\frac{2}{3}$ resolution. If the received signal is digitized and de-interlaced the missing line can be interpolated from the other 2 lines representing a full frame of lines for motion areas. Whether the signal is 24 or 36 FPS based the completed stored frames could be read from memory in a progressive or 2:1 interlace fashion.

4 Phase State Rotating Chroma combined with a **3:1 Interlace** — A 3:1 interlace produces harmonics that are spaced at the frame rate for both Luma & Chroma. When the Chroma is placed at the $\frac{1}{2}$ cycle/line offset and not rotated Luma/Chroma adjacent cluster harmonics do not interfere with each other but Chroma interference does occur to Luma $1\frac{1}{2}$ clusters away when the proper number of scan lines are used for a 3:1 interlace and 4 state Chroma. Rotating the Chroma phase at the H/4 rate shifts all Chroma harmonics $\pm\frac{1}{2}$ frame rate and off of the Luma harmonics. The combined fine mesh spectrum is an alternate of Luma & Chroma harmonics evenly spaced at $\frac{1}{2}$ the frame rate, just as it is with NTSC. It seems that a 4 phase state Chroma signal, be it **CRP**[™] or PAL is better suited using a 3:1 interlace although a PAL Chroma signal is less balanced so **CRP**[™] with TruColor[™] should offer better phase variance cancellation during marginal signal conditions. Since the phase reversal of the Chroma signal happens on a per line basis within a whole frame for a 3:1 interlace Hanover lines are created instead of Hanover bars making any on screen severe phase

variance effects twice as fine as a PAL 2:1 interlace system when not using a delay line. A 3:1 interlace offers an alternating pattern for both field and frame lines. For 4 state CRP™ that means phase rotation reversal and for 2 state NTSC it means phase inversion. There are no adjacent lines in a completed frame that are in the same state.

Vertical Sync Pulse Staggering – While it can be demonstrated that a 3:1 interlace when used with a 4 phase Chroma rotation system can produce a simple diagonal dot pattern the order in which the lines arrive for each sequential field does not provide optimal line alignment for a frame. By delaying or advancing a field by 1 field line (3 frame lines) in relation to the other two fields, depending on whether a $\frac{1}{3}$ or $\frac{2}{3}$ line offset is used, will align the Chroma dots in a uniform diagonal pattern. Also the diagonal shifting pattern of the Chroma dots for a field is in the opposite direction of a completed frame. While this solution may seem like a kluge, i.e. adding the frame rate to the Chroma frequency in PAL, it does not alter the precise structural relationship between the Chroma and horizontal frequencies thus maintaining the precise $\frac{1}{2}$ cycle/line offset and simplicity in digital processing. Only the video signal information is slightly altered on a per line basis not the base format structure of the signal. For vertical lines on a screen it is of no consequence and the spectral content of the signal would look essentially the same as a non-staggered arrangement. However a diagonal line on screen using sync staggering would look like a saw tooth when displayed with an un-staggered sync pulse and may correlate with a slightly more complex spectral emission which should not produce any critical issues. Video signal content alone in a non-staggered system may produce a similar spectral effect if a diagonal line had a saw tooth characteristic to it. For 2:1 interlace PAL in lieu of adding the frame rate to the chroma frequency using staggered sync pulses would maintain a perfect $\frac{3}{4}$ cycle/line offset providing digital processing simplicity and only a slight adjustment to the horizontal (15625.08811Hz) and vertical (50.00028194Hz) frequencies for which a conventional PAL receiver can handle. Using a 625 line analysis with a 2:1 interlace shows that a staggering of 2 field lines (4 frame lines) is needed to create the 180° chroma phase inversion at the start of a new field. Delaying either the even or odd field lines by 2 field lines will create the same pattern that adding the number of frame rate cycles to the Chroma frequency does. Staggering would create issues for PAL receivers using a TBC to generate an evenly spaced vertical sync pulse. 613, 621 or 629 scan lines will also work in lieu of vertical sync staggering.

Synergy – TruColor™ with its symmetrical and level balanced color wheel, CRP™ with its electrically balanced rotation scheme, 3:1 interlace producing a 2 frame uniform dot pattern and repeat rate like NTSC, and 24FPS film speed, all work together to create a fully optimized analog Color TV signal that has the hue correction feature of PAL with optimized performance, a Luma/Chroma composite spectrum with NTSC's $\frac{1}{2}$ frame rate spacing, a frame rate that allows a seamless conversion from film to video and a signal that is easily digitized. All of this is accomplished with normal and conventional analog TV signal formatting and possible more than 60 years ago. If only all of this was thought of back then.

The $\Sigma H S \lambda$ to $\lambda U V$ TruColor™ Marix

(Yet Another Chroma Matrix ;-). What NTSC should have been?

A method for converting $\Sigma H S \lambda$ Color with a modified **Luma**(λ) to analog Color TV $\lambda U V$ to balance for better **Chroma** (**UV**) matrixing.

- Where: Σ = **Chroma** level is a vector matrix sum/difference and not a saturation percentage factor.
 H = Hue of the **Chroma** signal in θ° derived from the quadrature matrix.
 S = Saturation level (R) of the **Chroma** signal as quadrature summation of the U & V vectors.
 λ = Brightness, or intensity factor of the **Luma** signal.

12-bit Luminance.

20-bit Polar Color Definition.

(Where **Chroma** scaling for R & θ° is assigned 20 Bits)

Matrixing

Let:

$$\begin{matrix} R = \text{Red} \\ G = \text{Green} \\ B = \text{Blue} \end{matrix} \quad \left. \begin{matrix} \backslash \\ / \end{matrix} \right\} \text{ Each range from } 0 \text{ to } 1.$$

- λ = Matrixed **B & W** **Luma** sub-channel.
 U = Matrixed **Blue** **Chroma** sub-channel.
 V = Matrixed **Red** **Chroma** sub-channel.
 W = Matrixed **Green** **Chroma** sub-channel.

Enhanced channels:

- I = Matrixed **Flesh** **Chroma** sub-channel (Hi-Res).
 Q = Matrixed **Purple** **Chroma** sub-channel (Lo-Res).

We have:

$$\begin{aligned} \lambda &= +1/7 \times B + 2/7 \times R + 4/7 \times G \\ B - \lambda &= +6/7 \times B - 2/7 \times R - 4/7 \times G \\ R - \lambda &= -1/7 \times B + 5/7 \times R - 4/7 \times G \\ G - \lambda &= -1/7 \times B - 2/7 \times R + 3/7 \times G \\ G - \lambda &= -\frac{1}{4} \times (B - \lambda) - \frac{1}{2} \times (R - \lambda) \end{aligned}$$

Encode:

$$\begin{aligned} \text{If: } U(x) &= \sqrt{3}/2 \times (B - \lambda) \times \theta^\circ \\ V(y) &= (R - \lambda) \times 90^\circ \end{aligned} \quad \left. \begin{matrix} \text{Quadrature} \\ \text{Sub-Carrier} \end{matrix} \right\} \begin{matrix} | \\ | \end{matrix}$$

Then: $W = \sqrt{3} \times (G - \lambda) @ 240^\circ$

Chroma Vector $R = \sqrt{U^2 + V^2}$
Chroma Hue $\theta = [aTan2(V,U) ; \text{If } \theta < 0 \text{ Then } \theta + 2\pi]$

Decode:

SyncDet

$$\begin{aligned} U: B - \lambda &= \text{---} @ \theta^\circ \div \sqrt{3}/2 \\ V: R - \lambda &= \text{---} @ 90^\circ \\ W: G - \lambda &= \text{---} @ 240^\circ \div \sqrt{3} \end{aligned}$$

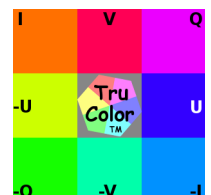

100% Color Bars

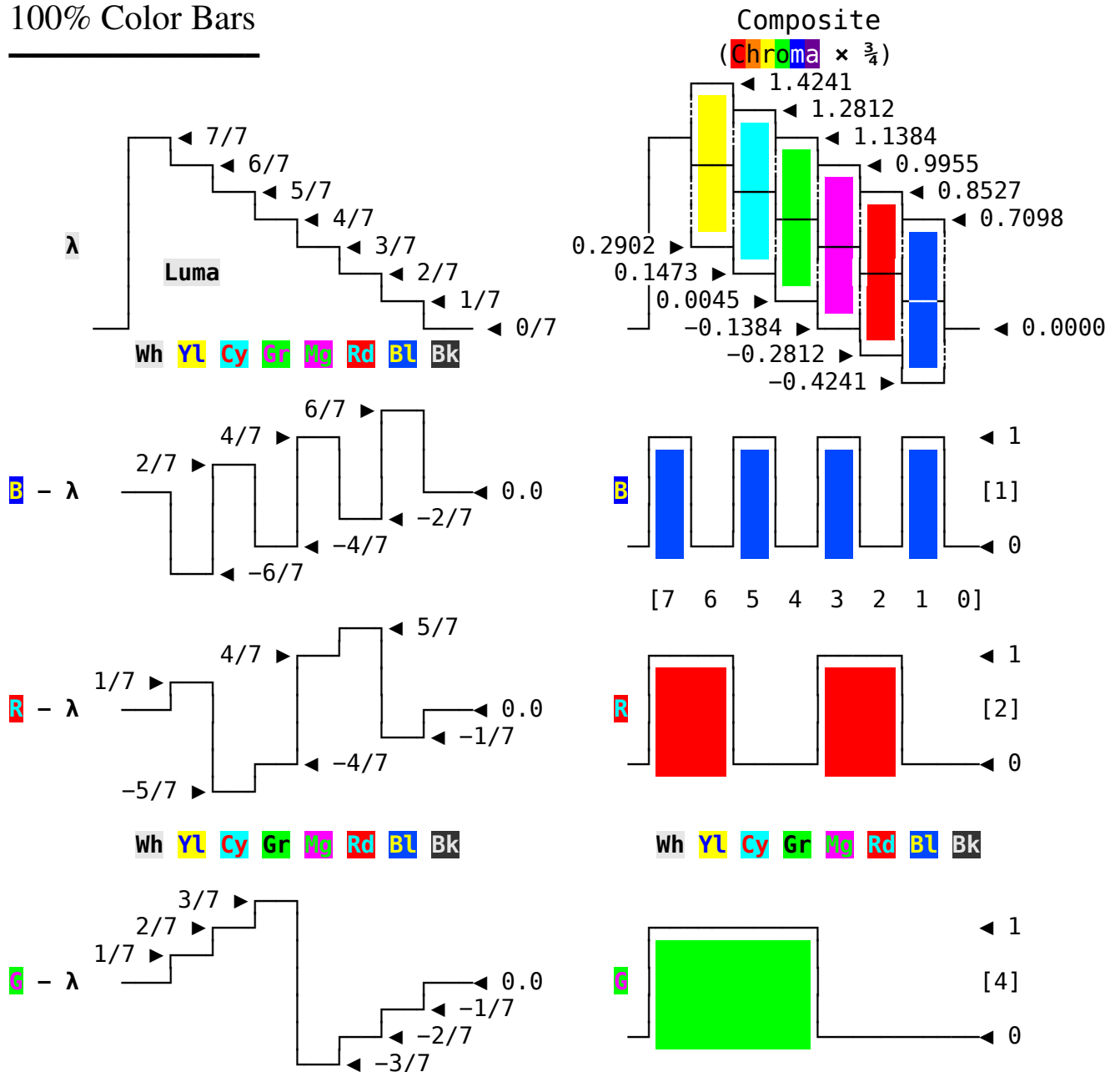

Color Bar	Luma Level	Rectangular		Polar	
		Chroma $U \times \sqrt{3}/2$	Levels V	Chroma Hue θ	Chroma Peak Level
White	100.00%	N/A	N/A	N/A	N/A
Yellow	85.71%	$-3 \times \sqrt{3}/7$	+1/7	169.11°	$2/\sqrt{7}$
Cyan	71.43%	$+1 \times \sqrt{3}/7$	-5/7	289.11°	$2/\sqrt{7}$
Green	57.14%	$-2 \times \sqrt{3}/7$	-4/7	229.11°	$2/\sqrt{7}$
Magenta	42.86%	$+2 \times \sqrt{3}/7$	+4/7	49.11°	$2/\sqrt{7}$
Red	28.57%	$-1 \times \sqrt{3}/7$	+5/7	109.11°	$2/\sqrt{7}$
Blue	14.28%	$+3 \times \sqrt{3}/7$	-1/7	349.11°	$2/\sqrt{7}$
Black	0.00%	N/A	N/A	N/A	N/A

The composite **Chroma** $\times \frac{3}{4}$ scaling for all colors with full saturation produces a level of **0.5669pk** or **1.134p-p** when modulated. When combined with **Luma** the **Luma + Chroma** peak for **Yellow** is at **142 $\frac{2}{5}$ %**, and **Blue** is at **-42 $\frac{2}{5}$ %**, slightly more foot room than PAL for **Blue** when composite scaling is applied with sync + setup added.

There is a 60° separation between the **MgRdYlGrCyBl** color axes respectively for the composite **Chroma** and all **Chroma** levels for each color at full saturation are equal to each other thus creating a perfect hexagon in the vector image .



The Enhanced **Chroma** Channels:

Flesh (I)	135°	$(V - U) \div \sqrt{2}$
Purple (Q)	45°	$(U + V) \div \sqrt{2}$

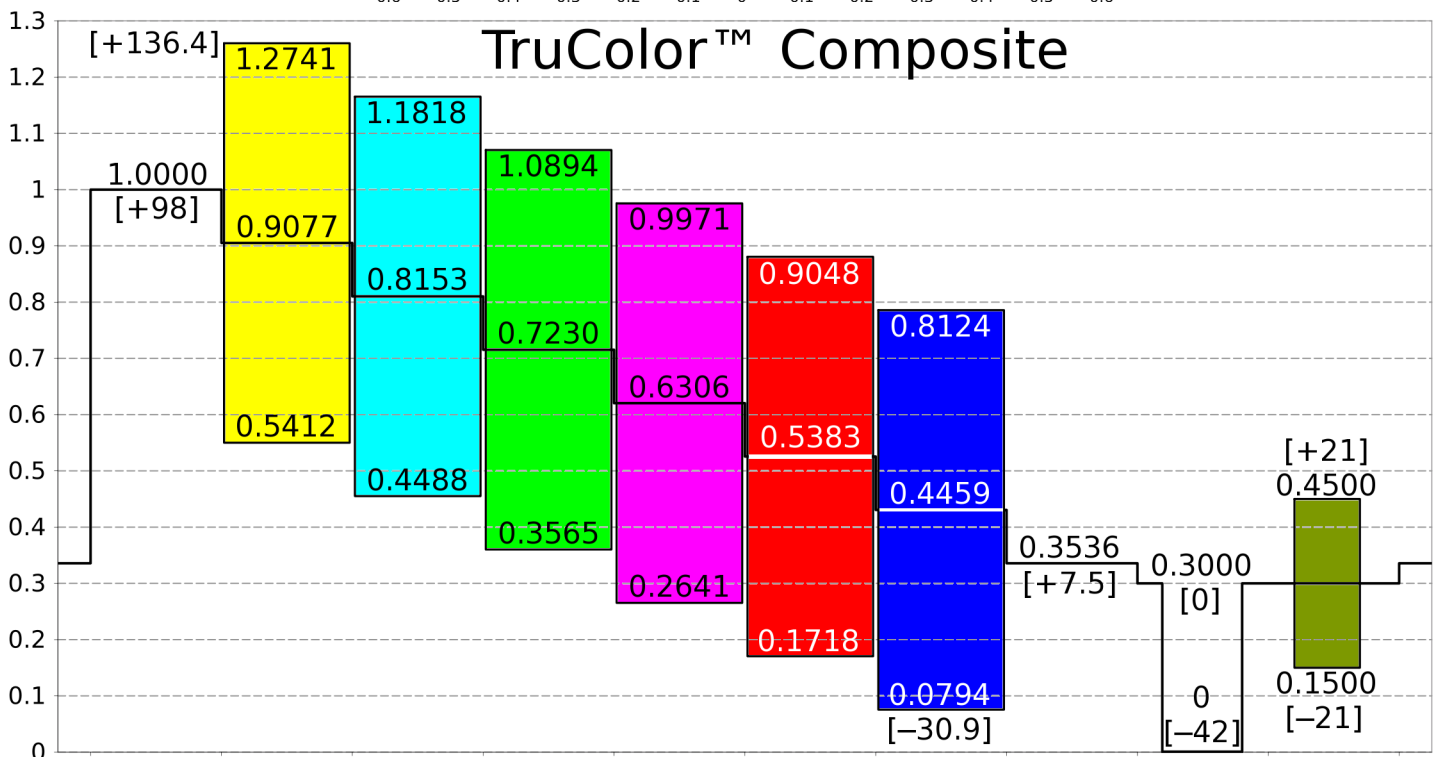
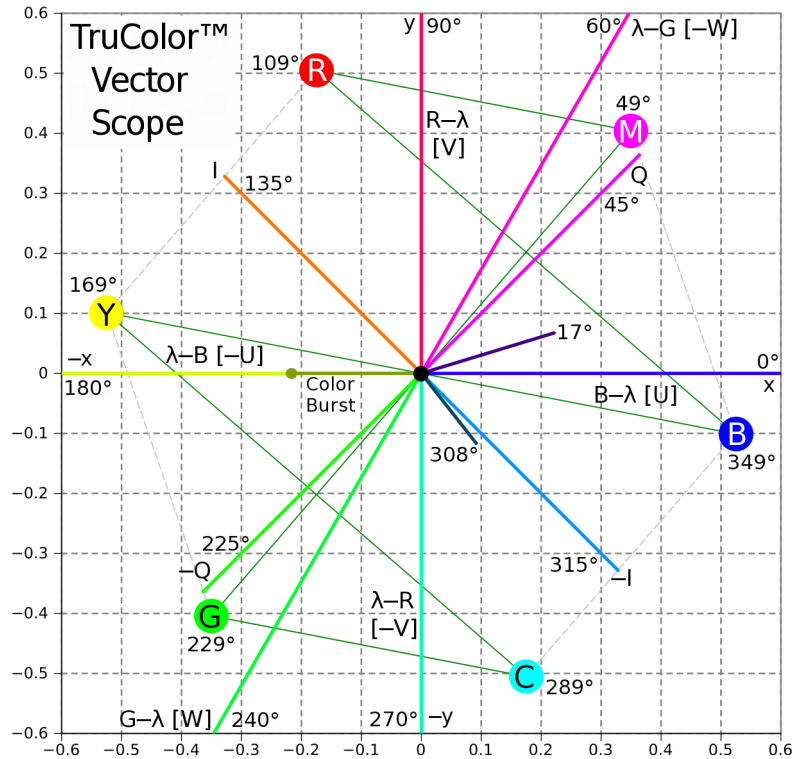

Graphically signal levels in the 2 images above are scaled for **Chroma** @ $\sqrt{2}/2$ for a **Luma** of 0 to 1. Composite image is scaled with a **Luma** of [93] (0.6643) & SetUp of [5]. The newer adjusted level labels in the composite are now for a $\frac{3}{4}$ **Chroma** scaling for a 0 to 1 **Luma** of [90½] (0.64643) with a SetUp of [7½]. Sync & Burst levels unchanged.

Analog Scaling

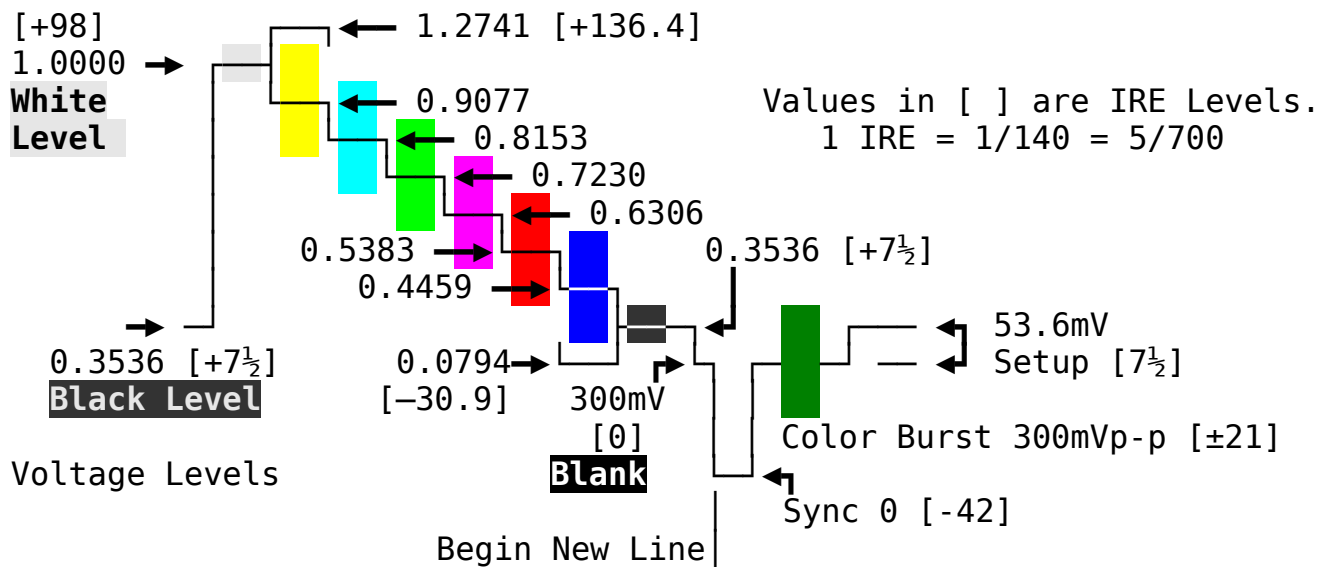

$$\lambda = \text{Luma} ; \text{Chroma} = \text{Quadrature} \begin{matrix} \text{+} \\ \text{-} \end{matrix} \times \text{Chroma} \frac{3}{4} \text{ Reduction} [105]$$

$$\text{Composite} = (\text{Luma} + \text{Chroma}) \times 0.64642857 + 0.35357143 \text{ (sync + setup } [49\frac{1}{2}]) [90\frac{1}{2}]$$

For a 1Vp-p B & W video signal with sync 0.6464 composite scaling is used with a Chroma level of 733mVp-p for each color, on par with the Luma : Chroma NTSC RMS ratio. Blanking level is exactly 300mV [-42]. ColorBurst is 300mVp-p [±21], centered on blanking level, 150mV [-21] to 450mV [+21].

Digital Scaling

Digital scaling uses Luma & Chroma values prior to composite scaling. The power factor is for A/D and does not include the analog display gamma correction. The extra bit can denote motion.

$$\text{Luma} \quad \lambda, \text{ Where } 0 \leq \lambda \leq 1$$

$$12\text{-Bit Scaling} = \lambda \times 4095 \quad [\text{Power Factor } 2^{12} ; 4096:1 \text{ Contrast}]$$

$$\text{Chroma Vector } R = \sqrt{U^2 + V^2}, \text{ Where } 0 \leq R \leq 2/\sqrt{7}$$

$$10\text{-Bit Scaling} = R \times (3095.529034 \div 2/\sqrt{7}) \quad [\text{Power Factor } 2.2339502^{10}]$$

$$\text{Chroma Hue } \theta = [a \text{Tan}2(V,U) ; \text{If } \theta < 0 \text{ Then } \theta + 2\pi]$$

$$9\text{-Bit Scaling} = \theta \times (511 \div 2\pi), \text{ Where } 0 \leq \theta \leq 2\pi$$

The natural Chroma phasing here will set the colors at:

Red @ 109.11° , Green @ 229.11° , Blue @ 349.11°

this is different than the NTSC/PAL spacing, but to align the hue with the standard HSV space and to place Red at 0° rotating the phase by -109.1066° is desirable before bit scaling is done. In order to produce a balanced color wheel for the Chroma signal, placing the MgRdYlGrCyBl axes 60° apart, the RGB weighting for the Luma is balanced to integer ratios of:

Red @ 28.57% , **Green** @ 57.14% , **Blue** @ 14.29%

which are the fractions 2/7, 4/7, and 1/7 respectively and the 'U' **Chroma** channel was reduced by $\sqrt{3}/2$, $\sin(60^\circ)$, before quadrature matrixing. When the standard color bars  are processed an even level stair step for the **Luma** signal is produced. This is a slight variation from the **YUV Luma** weighting used for NTSC/PAL which is:

Red @ 29.9% , **Green** @ 58.7% , **Blue** @ 11.4%

and is not a noticeable difference for the black & white portion of the signal.

While this is defined as a 32 bit encoding it could be defined with 24 bits or less as well but with lower resolution. Defining both the **Luma** and **Chroma** as levels and the hue as a phase allows for more efficient use of the assigned bits. Regarding phase this could be defined as a palette with non-linear assignment around the color circle to optimize the color perception of the eye and/or scene optimization of image. This palette also could be dynamic as the scene changes. For the more sensitive hues to the eye and/or scene use smaller steps and in the less sensitive areas larger steps thus reducing the number of bits necessary for the same color range. The eye is also less sensitive to color saturation than to overall intensity so having both the **Luma** and **Chroma** intensity channels separate from the hue allows for better **Luma/Chroma** bit balance for best fidelity. Dithering of the **Chroma** signal in both hue and level would also help to minimize the perception of using a lower bit level.

For example: 24 bit = 8 **Hue**, 7 Saturation, 9 **Luma**

NOTES:

The ' λ ' (Lambda) symbol is used for the **Luma** instead of 'Y' to differentiate the altered **Luma** weighting from the standard NTSC/PAL weighting.

The ' Σ ' (Sigma) symbol denotes that this HSL color space uses a sum/difference method to matrix the **Red**, **Green**, and **Blue** signals into the **Luma** & **Chroma** channels and not a scaling percentage for the **Chroma** saturation.

Copyright ©2012, ©Jan2017 - J. S. Gilstrap (KD5TVJ) All Rights Reserved.

Chroma Rotary Phase™

Vector [phase] rotation by 90° for each horizontal line is a process used in **VHS** video recording for the **Chroma** signal. The lack of signal stability in the tape's higher frequency range is inadequate to record the **Chroma** signal but in the lower frequencies it is minimal but is still present. The head azimuth angle used to eliminate adjacent track cross-talk in the higher frequencies for **Luma** recording is ineffective in the lower frequencies. Vector [phase] rotation increases signal stability and cancels out adjacent track cross talk which would degrade the signal.

The **Chroma** signal is heterodyned down to 629kHz in a process called color under. During the heterodyning process the mixers use an oscillator with quadrature outputs that rotates the mixer phase by 90° for each line in opposite directions for each head so the phase will rotate through 360° in 4 lines before repeating and then being put onto tape. During playback they are up converted back to the original sub-carrier frequency and the mixer phases are rotated in opposite directions reversing the rotations and restoring the **Chroma** to its original phasing. A comb filter is used during playback to cancel out cross talk and phase jitter.

Chroma Rotary Phase™ can be used to reduce **Chroma** signal degradation during transmission. The **Chroma** modulators will rotate the two sub-carrier phases by **90°** per line for the **B-λ** & **R-λ** signals in opposite directions instead of for each head as it is done in **VHS**. In **NTSC** the **Chroma** sub-carrier frequency is an odd multiple of $\frac{1}{2}$ the horizontal frequency which causes the clusters of **Chroma** energy to sit in between the clusters of **Luma** energy in a process called interleaving. As a result each horizontal line ends with only $\frac{1}{2}$ cycle of the **Chroma** sub-carrier inverting the phase **180°** for both **B-λ** & **R-λ** in relation to the previous line on the screen. This is sometimes seen as a diagonal dot crawl pattern on the screen. When phase rotation is applied it also causes the vectors on screen to rotate in opposite directions compared to the electrical signal.

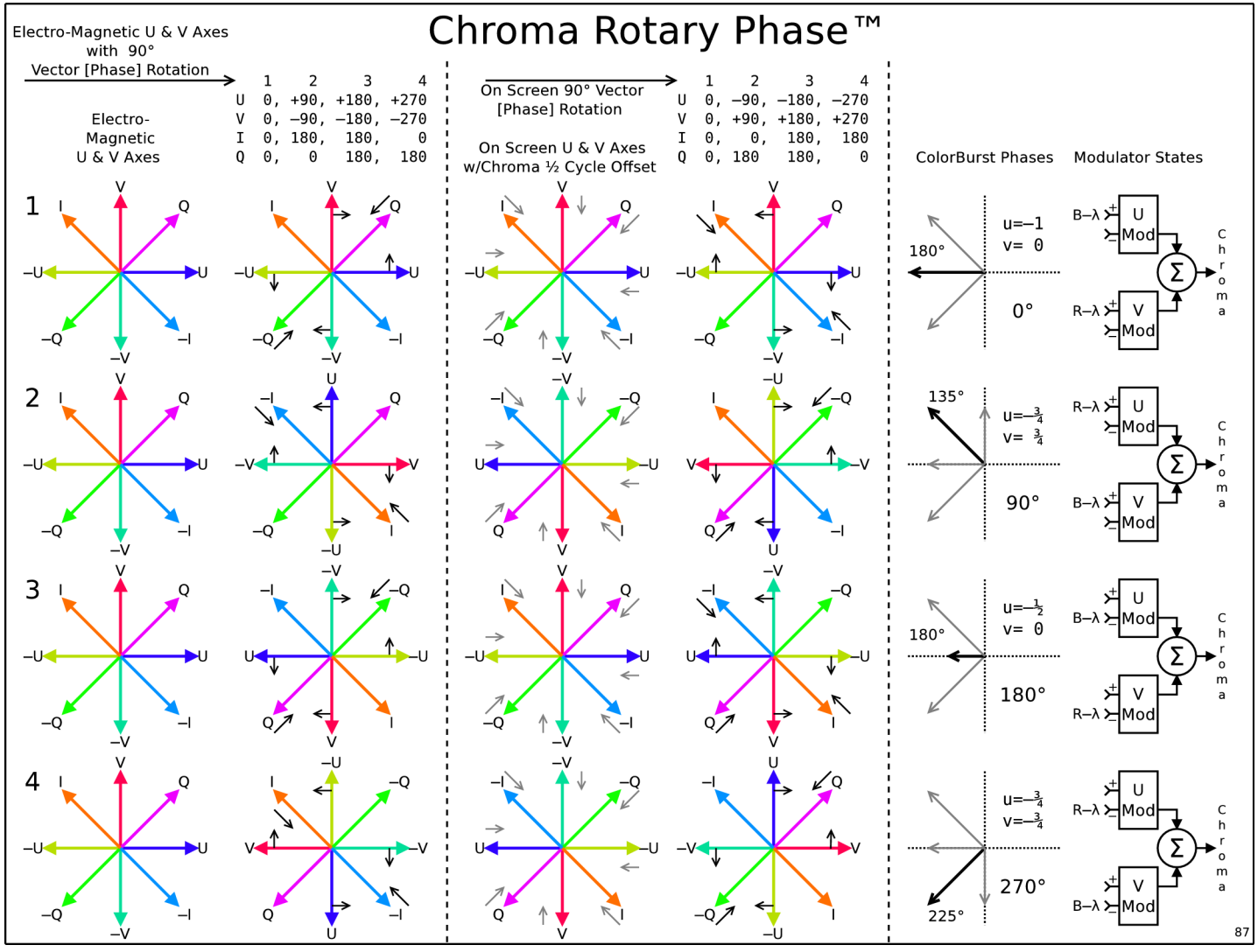

In the image above are 4 video lines labeled **1, 2, 3, & 4**. The **1st** column of vectors are of the **U & V** electrical axes. The **2nd** column of vectors are of the **U & V** electrical axes rotated **90°** per line. The **3rd** column of vectors shows the natural phase inversion created by each line ending with only $\frac{1}{2}$ cycle of the **Chroma** sub-carrier inverting the phase **180°** for every other line as displayed on screen but in reference to the **ColorBurst** PLL lock the phase has not inverted. The **4th** column shows how the vectors are positioned on the screen when the **U & V** axes rotate by **90°** per line. The **5th** column shows how the **ColorBurst** angle is used with each rotation for identification. In the **6th** column are the **U & V** modulators and how the modulating signals are applied for each line. Line **1** is normal having the **B-λ** & **R-λ** signals sent to their respective **U & V** modulators. In line **2** the signals have swapped modulators and use the **+** inputs. In line **3** the signals are swapped back to their original modulators but use the **-** inputs this time. In line **4** the signals have swapped modulators again but use the **-** inputs instead. The process then repeats itself for another set of 4 lines. To decode the rotation process is reversed at the receiver and the use of a comb filter provides an added benefit.

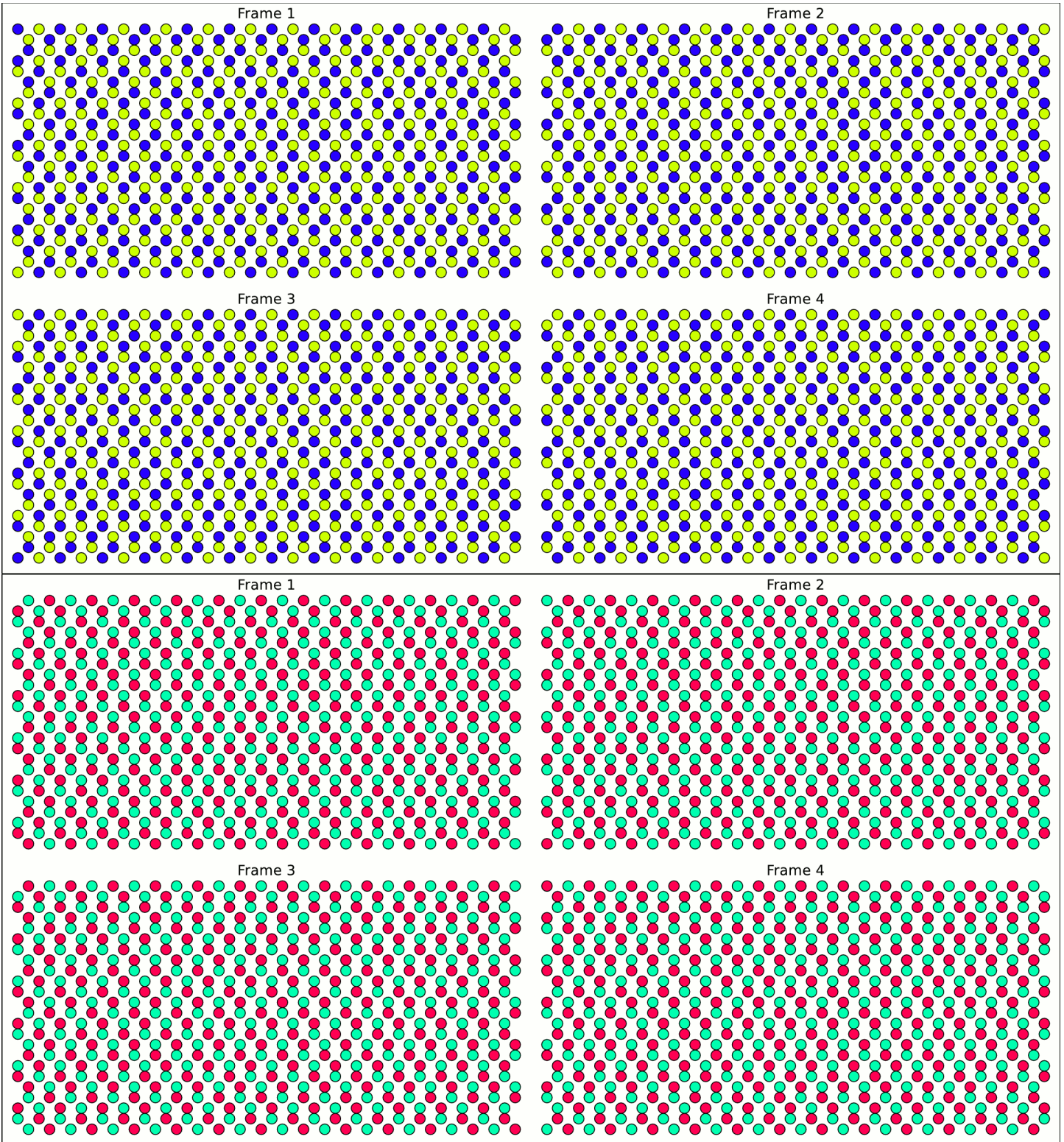

In the images above are the **B-λ** & **R-λ** dot patterns separated out into 2 images. These patterns are for an odd number of lines per frame needed for a 2 : 1 interlace. Since **Chroma Rotary Phase™** needs 4 lines to repeat the pattern and the **Chroma** ends each line with $\frac{1}{2}$ cycle, 4 frames or 8 fields are needed for a 525 line frame for a total of 2100 lines. $525 \times 4 = 2100$. For a 60Hz field rate the repeat period is 133ms. If the number of lines per frame were even and odd for a field then the repeat rate would be over 2 frames at 67ms as it is in NTSC but this would break the interlace offset created by the odd number of lines per frame. Using an odd number of lines per frame with a 2 : 1 interlace allows a field to end with $\frac{1}{2}$ of a line causing the lines in each field to sit in between each other on screen. As seen in the image on the next page the pattern is more randomized than it would be for regular NTSC **Chroma** and this may help compensate for the slower repeat rate of 4 frames instead

of 2 or may create other moiré type patterns not seen in regular NTSC Chroma on certain program material if not properly filtered before Chroma generation. Below are the axes as coordinated colored dots as displayed on screen for Chroma Rotary Phase™.

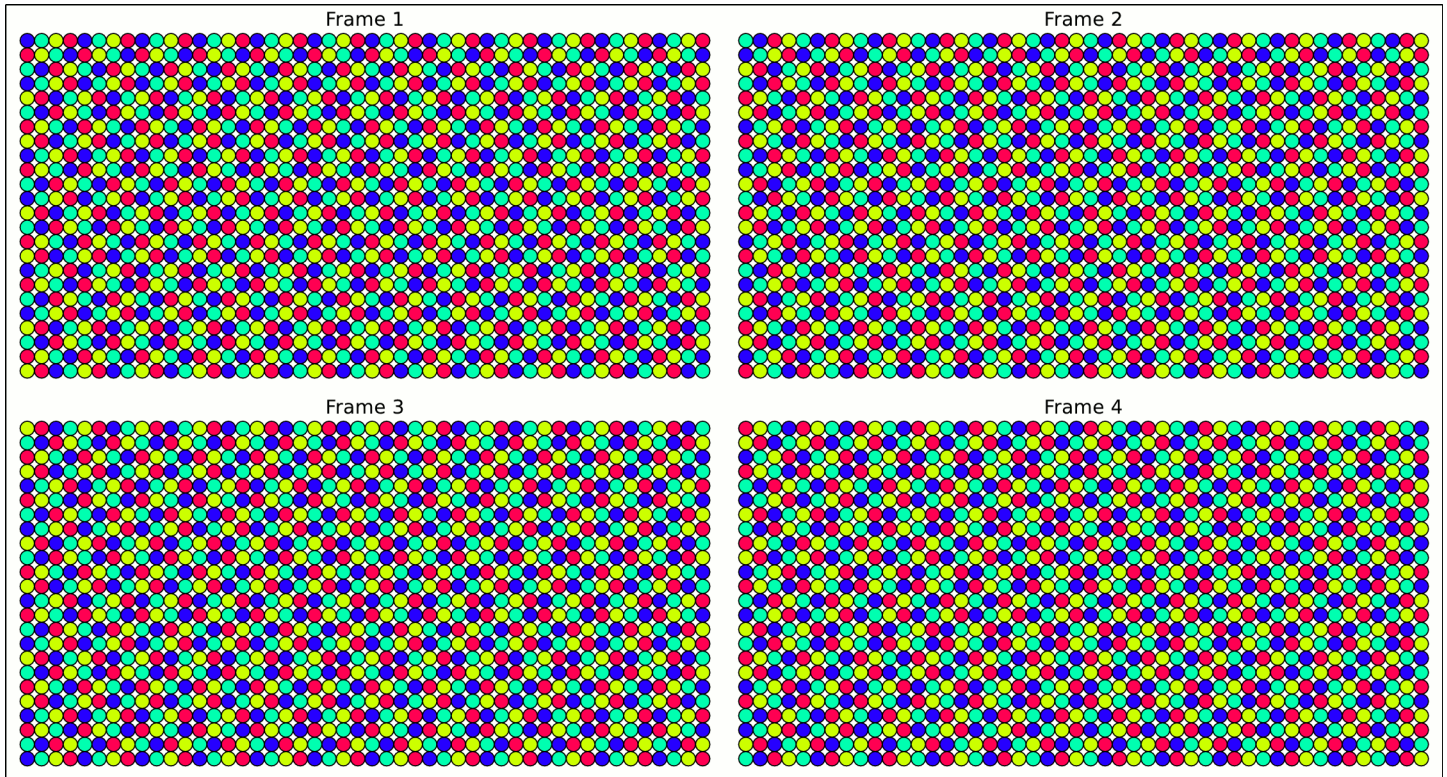

Next are the dot patterns for regular NTSC Chroma.

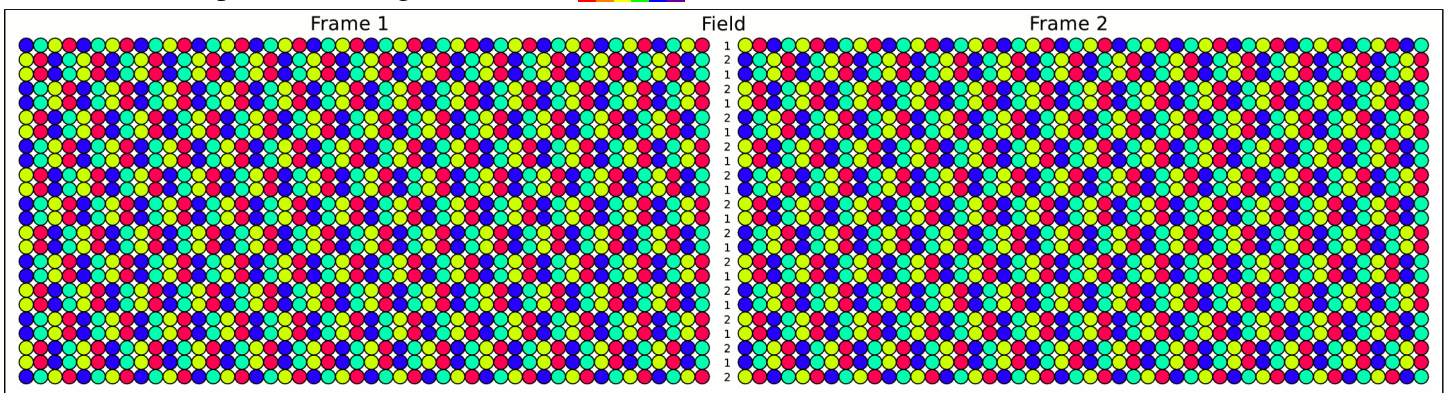

Wider Screen High Definition WXGA 720i72 / 720p24 CRP™ for a 6mHz Channel Space

For the vertical scan a 3:1 interlace is used at a field rate of 72 Hz to produce the Film standard 24 frames per second. For the horizontal scan a 4:1 pixel interlaced sub-nyquist sampling is used to almost triple the Luma resolution, à la MUSE Hi-Vision. Below is a rough layout of the specification. It takes $\frac{1}{6}$ of a second (166ms), 4 full frames (12 fields) to receive the full high definition image. A frame buffer is used to store the 4 frames to assemble a full resolution still picture. For motion the 72 Hz field rate will provide a reduced resolution de-interlaced image with motion blur every $13.\bar{8}$ ms. The sound is on a 4.8 mHz sub-carrier that can handle 3 separate channels of audio, L+R, L-R, and SAP or Surround.

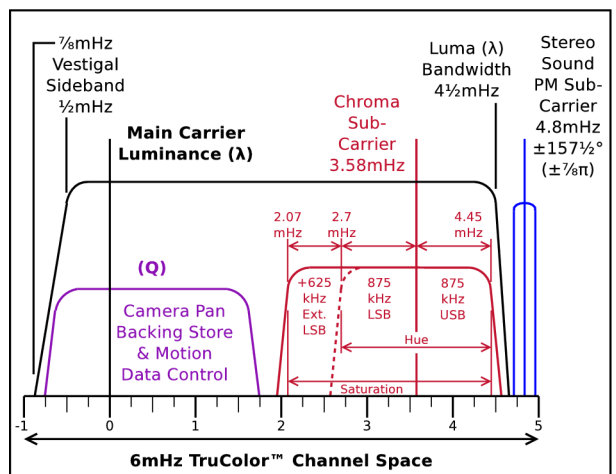

General:

Aspect Ratio 74:45 = 1.64
Total Picture Pixels (Digital) 1184×720 ; 852480 Pixels
Kell Factor (Analog Resolution) 837×509 ; 426240 Pixels
Sub-Nyquist(x) & Interlace(y) 296×240 (4:1 & 3:1)
(24.005, +0.02075%)
[24.0375, +0.1563%]

Vertical:

Frames Per Second 24 Hz [24.0111, +0.0462%]
Total Lines Per Frame 790 (2 Frame CRP™ Dot Repeat)
Fields Per Second 72 Hz [72.0333] [72.1125] (72.0149)
Total Lines Per Field 263 $\frac{1}{3}$
Picture Lines 240
Lines Per Blank 23 $\frac{1}{3}$
Blank 1.23 ms
Sync 211 μ s ; 4 Lines

Horizontal:

Resolution Good:300 Max@-8dB:370
Freq, Period (H_P), Clock Pixel/Line 18.96 kHz, 52.743 μ s, [18.968759] [18.989629]
Picture BW Pixels 311 \approx 1 $\frac{3}{5}$ × λ BW×(H_P-H_B) ; (296+15) \approx 4 $\frac{5}{8}$ % OverScan
Total Picture Clock ; Period 311 ; 43.51 μ s (18.963934)
Blank (H_B) 66 ; 9.233 μ s
Front Porch 7 ; 0.979 μ s
Sync 25 ; 3.498 μ s
Back Porch 34 ; 4.757 μ s

Luma & Chroma:

Luma (λ) Bandwidth @-3dB 4 $\frac{1}{2}$ mHz ; Vestigial $\frac{7}{8}$ mHz, Corner $\frac{1}{2}$ mHz
Chroma: Sub-Sampling 6 $\frac{1}{5}$:1:1 $\frac{1}{2}$
Sub-Carrier 3.57396 mHz [3.575611 PAL-M] (3.5747015)
 $\frac{1}{2}$ H Odd Harmonic 377 (188 $\frac{1}{2}$) [3.579545 NTSC]
Saturation Bandwidth 2 mHz (USB + $\frac{7}{8}$ mHz & LSB -2mHz)
Hue Bandwidth $\frac{7}{8}$ mHz (USB + $\frac{7}{8}$ mHz & LSB - $\frac{7}{8}$ mHz)
Color Burst Duration 2.798 μ s ; 10 cycles 2×(2 $\frac{3}{4}$ +10+4 $\frac{1}{4}$)=34
Baseband Guard 1 $\frac{1}{4}$ mHz

Stereo Sound:

PM SubCarrier $\pm 157\frac{1}{2}^\circ \pm \frac{7}{8}\pi \pm 2\frac{3}{4}R$ 4.79688 mHz [4.7990959] [4.804376] (4.7978752)
H Harmonic 253
L & R Frequency Response L+R 50Hz-15kHz, L-R 125Hz-15kHz
Equalization 75 μ s Pre-Emphasis, Shelf at 12.73kHz (12 $\frac{1}{2}$ μ s)
Harmonic Peak Shifting 65 μ s & 650 μ s Phase Shift Networks (Optional)
L-R Sub-Carrier 2×H 37.92 kHz [37.937517] [37.979257] (37.927867)
Modulation Unlimited Armstrong PM $\pm 74^\circ$, Peak Q:I=3 $\frac{1}{2}$
Comander Controlled 'I' Channel



Using a 3:1 interlace with a $\frac{1}{3}$ line offset allows the use of an even number of lines per frame providing a 2 frame repeat rate when using Chroma Rotary Phase™. The dot pattern is a little less randomized than a Chroma Rotary Phase™ 2:1 interlace but a little more than the regular NTSC Chroma 2:1 interlace. Whether the randomness with a 2 frame repeat rate is enough to outweigh the other two 2:1 interlace modes is unknown. The B- λ & R- λ patterns are completely diagonal at 45° per frame whereas the NTSC Chroma 2:1 interlace have the same pattern between fields for line pairs which are also at 45°. Interlacing is accomplished by delaying the vertical sync pulse by a fraction of a line. For a 2:1 interlace the delay would be $\frac{1}{2}$ line using an odd number of lines or for a 3:1 interlace it would be $\frac{1}{3}$ line where the number of lines per frame divided by 3 would produce the number of lines per field ending with $\frac{1}{3}$ line. On screen field 2 would start $\frac{1}{3}$ line later than field 1 and field 3 would start $\frac{1}{3}$ line later than 2. Unfortunately this would produce a larger and less uniform Chroma pattern than either of the other 2:1 interlace methods. To eliminate this and produce a uniform rotation pattern on screen the sync in field 1 starts on line 4 instead of line 1 within a frame shifting all the lines in field 1 up by 1 on screen. This will allow the use of the most optimal lines to start the fields within the 4 line

Chroma Rotary Phase™ repeat pattern. The 1st line in the odd frames on screen will start the 4 line **Chroma** rotation pattern at the beginning and every other frame line will have the **U & V Chroma** axes swapped as it is in every other field line but the 4 line rotation pattern is reversed from the field rotation direction. The even frames will start the **Chroma** rotation pattern in the middle to produce the 2 frame repeat rate.

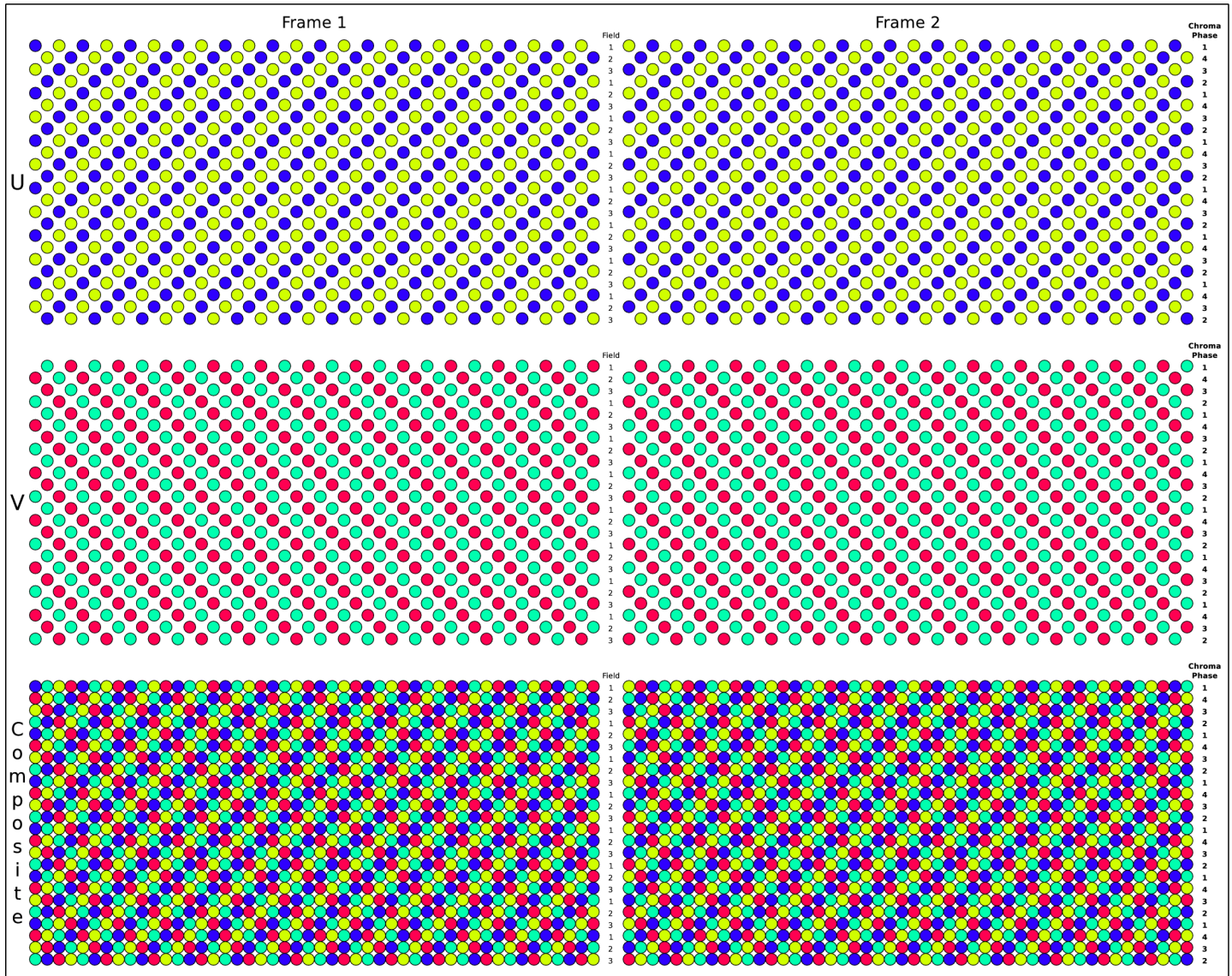

Above are the Composite, **B-λ** & **R-λ** dot patterns for a 3:1 interlace. On the bottom right is the pattern for the **I & Q** vectors. When any **Hue** falls on either one of these axes it will generate the same pattern as standard NTSC **Chroma** with the only difference in the pattern is that the **I & Q** line pairs are not on the same two lines but are offset by one line. This is of no consequence compared to NTSC since a **Hue** will fall on either one or the other axis however for the 3:1 interlace the dot crawl pattern will manifest itself different than it would for a 2:1 interlace. This will apply for all **Hues** and the angles of the dots will vary from vertical pairs at 45° if they fall on an I or Q axis to a pure ±45° if they fall on a **B-λ** or **R-λ** axis. The **U & V Chroma** axes swap on a per line basis instead of line pairs within a frame as it would be for a 2:1 interlace will make any **Hue** error effects on screen twice as fine if a comb filter is not used. It is the 3:1 interlace and selectively starting the fields within a frame with a 4-2-3 pattern that makes the **Chroma** rotation pattern lay down in this way on screen.

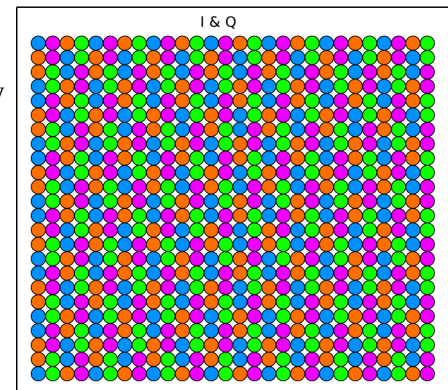

Pixel Interlaced Sub-Nyquist Sampling Patterns

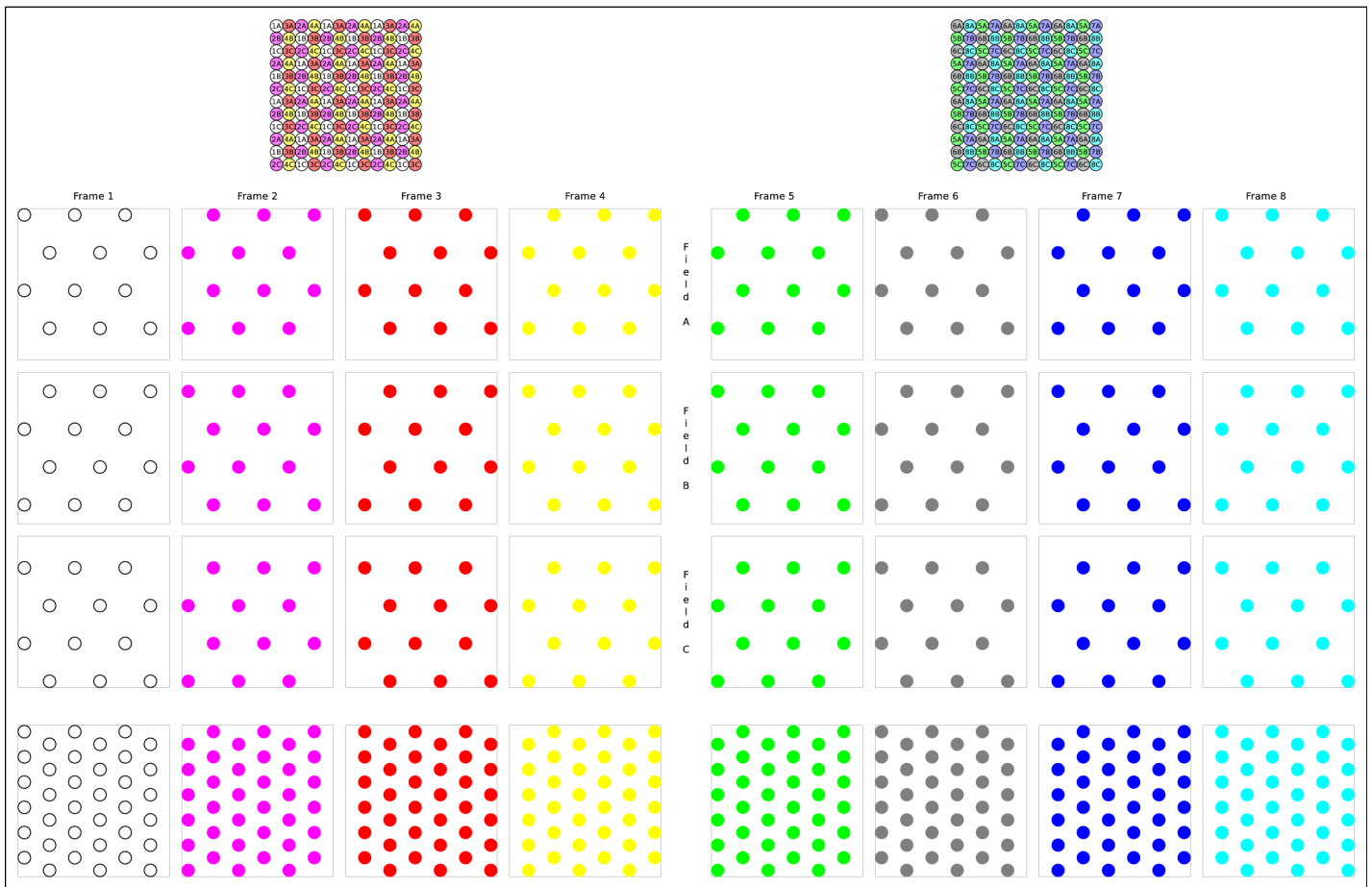

Above are the patterns for 24 fields of sub-nyquist samplings. This is just one method of creating an evenly dispersed pattern that provides effective sequential coverage temporally which seems to meet the requirements. There may be a more optimal arrangement that meets the requirements that offers better artifact concealment. The 8 column 3 row images are for the 3:1 interlaced ones and the bottom row are the 3:1 de-interlaced ones. The odd numbered frame dots are colored White (1), Red (3), Green (5), & Blue (7), and the even numbered frame dots with the same pattern are their complimentary colors Magenta (2), Yellow (4), Dark Gray (6), & Cyan (8). While 12 fields are only needed to complete 4 frames for the 4:1 sub-sampling for full resolution, for the next 4 frames each pixel needs to be sent in the other frame. **Chroma** Rotary Phase™ has a 2 frame repeat pattern where the **Chroma** signal on a per pixel basis is inverted 180° between the 2 frames. This allows for the averaging of the brightness fluctuations caused by the **Chroma** signal being superimposed on the Luma signal even at the fine level for the 4 high resolution pixels contained within a low resolution super pixel. For the high resolution pixels that fall on the first 4 even numbered frames within 8 frames will then fall on the next 4 odd numbered frames within 8 frames and vice-versa. When a frame buffer is used to store each frame for static image areas (without motion), having 8 frames stored will allow complete Luma / **Chroma** separation without using adjacent lines with no loss of high definition detail. When motion is present these portions are updated at the field rate, having the other lines in the other fields interpolated from the current field lines with the **Chroma** information also being separated from the Luma portion using several field lines should provide good separation at a lower resolution. Luma / **Chroma** separation will be incomplete but acceptable for motion areas around Luma intensity & **Hue** / Saturation edge changes. This will be mostly unnoticeable to the eye especially if the motion is fast. If the motion is slow or camera pans present motion vectors can be used in some cases to move high definition pixels instead of using the lower resolution field update mode. Once motion has stopped image processing will switch to static mode where the full high resolution area will be assembled in a shorter time than the eye will mostly notice. Several 8 frame groups can also be averaged into current static areas to provide temporal noise reduction. Adding / subtracting an odd and even frame with the same sample points will separate the Luma & **Chroma**. Adding a frame from the 1st set of 4 frames with a frame from the 2nd set of 4 where the order in the second set is swapped so **Chroma** can be canceled will allow recovery of each Luma sample point, 1 & 6, 2 & 5, 3 & 8, and 4 & 7 in $\frac{1}{3}$ of a second or $333\frac{1}{3}$ ms.

1280x720
Test Pattern



©2017
J. S.
Gilstrap
KD5TV

Tru
Color™

Chroma Rotary Phase™

Wide Screen Enhanced Definition WVGA 432i72 / 432p24 CRP™ for a 6mHz Channel Space

For the vertical scan a 3:1 interlace is used at a field rate of 72 Hz to produce the Film standard 24 frames per second. For the horizontal no sub-sampling will be used and the full refresh rate will also be at 24 frames per second, 41 $\frac{2}{3}$ ms. Using a 3:1 interlace at 72 Hz with 159 $\frac{1}{3}$ lines allows the use of a lower horizontal scan rate providing increased definition of the Luma channel and wider aspect ratio than the 4:3 definition image. Chroma Rotary Phase™ will be used instead of NTSC Chroma since its dot matrix pattern works better with the 3:1 interlace while still offering a two frame repeat pattern but the old 3.57mHz Chroma sub-carrier frequency will be used. The vestigial sideband has been reduced by $\frac{3}{8}$ mHz to increase Luma bandwidth to 4 $\frac{1}{2}$ mHz. This moves the sound to 4.8mHz having 3 separate channels of audio, L+R, L-R, and SAP or Surround.

General:

Aspect Ratio	16:9 = 1. $\bar{7}$	Good Contrast
Total Picture Pixels (Digital)	768×432 ; 331776 Pixels	97×54 ≈ 1.7963
Kell Factor (Analog Resolution)	543×305 ; 165888 Pixels	776×432 ; 335232
		549×305 ; 167616

Vertical:

	[24.0404, +0.168%]	(24.0079, +0.0328%)
Frames Per Second	24 Hz [24.014, +.0583%]	
Total Lines Per Frame	478 (2 Frame CRP™ Dot Repeat)	
Fields Per Second	72 Hz [72.042] [72.1212] (72.0236)	
Total Lines Per Field	159 $\frac{1}{3}$	
Picture Lines	144	
Lines Per Blank	15 $\frac{1}{3}$	
Blank	1.34 ms	
Sync	261.5 μs ; 3 Lines	

Horizontal:

	Resolution Good:549 Max@-8dB:679
Lines Per Second	11.472 kHz [11.478687] [11.491316] (11.475767)
Period (HP)	87.169 μs (623)
Picture	77.934 μs (557)
Total Picture Pixels	567 ≈ φ × λ _{BW} × (HP-HB) ; (549+18) ≈ 3 $\frac{1}{6}$ % Over Scan
Viewable Picture Pixels/Line	549 ; 75.46 μs
Blank (HB)	9.235 μs (66)
Front Porch	0.979 μs (7)
Sync	3.498 μs (25)
Back Porch	4.757 μs (34)

Luma & Chroma:

Luma (λ) Bandwidth @-3dB	4 $\frac{1}{2}$ mHz ; Vestigial $\frac{7}{8}$ mHz, Corner $\frac{1}{2}$ mHz
Chroma:	Sub-Sampling: 3:1: $\frac{5}{8}$
Sub-Carrier	3.573528 mHz [3.579545 NTSC] (3.5747015)
$\frac{1}{2}$ H Odd Harmonic	623 (311 $\frac{1}{2}$) [3.575611 PAL-M]
Saturation Bandwidth	1 $\frac{1}{2}$ mHz (USB + $\frac{7}{8}$ mHz & LSB -1 $\frac{1}{2}$ mHz)
Hue Bandwidth	$\frac{7}{8}$ mHz (USB + $\frac{7}{8}$ mHz & LSB - $\frac{7}{8}$ mHz)
Color Burst Duration	2.798 μs ; 10 cycles 2×(2 $\frac{3}{4}$ +10+4 $\frac{1}{4}$)=34
Baseband Guard	2 mHz

Stereo Sound:

PM SubCarrier ±157 $\frac{1}{2}$ ° ± $\frac{7}{8}$ π ±2 $\frac{3}{4}$ R	4.795296 mHz [4.7980912] [4.80337] (4.796870757)
H Harmonic	418
L & R Frequency Response	L+R 50Hz-12.5kHz, L-R 125Hz-12.5kHz
Equalization	75μs Pre-Emphasis, Shelf at 12.73kHz (12 $\frac{1}{2}$ μs)
Harmonic Peak Shifting	65μs & 650μs Phase Shift Networks (Optional)
L-R Sub-Carrier 3×H	34.416 kHz [34.436061] [34.473949] (34.427302)
Modulation	Unlimited Armstrong PM ±74°, Peak Q:I=3 $\frac{1}{2}$ Compander Controlled 'I' Channel

Wider Screen Enhanced Definition DVD 480i72 / 480p24 CRP™ for a 6mHz Channel Space

For the vertical scan a 3:1 interlace is used at a field rate of 72 Hz to produce the Film standard 24 frames per second. For the horizontal no sub-sampling will be used and the full refresh rate will also be at 24 frames per second, 41 $\frac{2}{3}$ ms. Using a 3:1 interlace at 72 Hz with 175 $\frac{1}{3}$ lines allows the use of a lower horizontal scan rate providing increased definition of the **Luma** channel and somewhat wider aspect ratio than the 4:3 definition image. **Chroma** Rotary Phase™ will be used instead of NTSC **Chroma** since its dot matrix pattern works better with the 3:1 interlace while still offering a two frame repeat pattern but the old **3.58mHz Chroma** sub-carrier frequency will be used. The vestigial sideband has been reduced by $\frac{3}{8}$ mHz to increase **Luma** bandwidth to 4 $\frac{1}{2}$ mHz. This moves the sound to **4.8mHz** having **3** separate channels of audio, **L+R**, **L-R**, and **SAP** or Surround.

General:

	3:2 = 1 $\frac{1}{2}$	Good Contrast
Aspect Ratio		87:60 = 1.45
Total Picture Pixels (Digital)	720×480 ; 345600 Pixels	696×480 ; 328320
Kell Factor (Analog Resolution)	509×340 ; 172800 Pixels	492×340 ; 164160

Vertical:

	[23.9779, -0.092%]
Frames Per Second	24 Hz [24.0043, +0.018%] (23.9718, -0.1174%)
Total Lines Per Frame	526 (2 Frame CRP™ Dot Repeat)
Fields Per Second	72 Hz [72.0129] [71.9338] (71.9155)
Total Lines Per Field	175 $\frac{1}{3}$
Picture Lines	160
Lines Per Blank	15 $\frac{1}{3}$
Blank	1.21 ms
Sync	238 μs ; 3 Lines

Horizontal:

	Resolution Good:492 Max@-8dB:608
Lines Per Second	12.624 kHz [12.626261] [12.612384] (12.609176)
Period (HP)	79.214 μs (567)
Picture	69.993 μs (501)
Total Picture Pixels	510 ≈ φ × λ _{BW} × (HP-HB) ; (492+18) ≈ 3 $\frac{1}{2}$ % Over Scan
Viewable Picture Pixels/Line	492 ; 67.523
Blank (HB)	9.221 μs (66)
Front Porch	0.978 μs (7)
Sync	3.493 μs (25)
Back Porch	4.750 μs (34)



Luma & Chroma:

Luma (λ) Bandwidth @-3dB	4 $\frac{1}{2}$ mHz ; Vestigial $\frac{7}{8}$ mHz, Corner $\frac{1}{2}$ mHz
Chroma:	Sub-Sampling: 3:1:5 $\frac{5}{8}$
Sub-Carrier	3.578904 mHz [3.579545 NTSC] (<u>3.5747015</u>)
$\frac{1}{2}$ H Odd Harmonic	567 (283 $\frac{1}{2}$) [3.575611 PAL-M]
Saturation Bandwidth	1 $\frac{1}{2}$ mHz (USB + $\frac{7}{8}$ mHz & LSB -1 $\frac{1}{2}$ mHz)
Hue Bandwidth	$\frac{7}{8}$ mHz (USB + $\frac{7}{8}$ mHz & LSB - $\frac{7}{8}$ mHz) (U:1 $\frac{1}{2}$ @5 $\frac{5}{8}$)
Color Burst Duration	2.794 μs ; 10 cycles 2×(2 $\frac{3}{4}$ +10+4 $\frac{1}{4}$)=34
Baseband Guard	2 mHz

Stereo Sound:

PM SubCarrier ±157 $\frac{1}{2}$ ° ± $\frac{7}{8}$ π ±2 $\frac{3}{4}$ R	4.79712 mHz [4.7979792] (4.791487)
H Harmonic	380 [4.7927061]
L & R Frequency Response	L+R 50Hz-15kHz, L-R 125Hz-15kHz
Equalization	75μs Pre-Emphasis, Shelf at 12.73kHz (12 $\frac{1}{2}$ μs)
Harmonic Peak Shifting	65μs & 650μs Phase Shift Networks (Optional)
L-R Sub-Carrier 3×H	37.872 kHz [37.837153] [37.878783] (37.827529)
Modulation	Unlimited Armstrong PM ±74°, Peak Q:I=3 $\frac{1}{2}$
	Compander Controlled 'I' Channel

The next page is a 720×480 test pattern.



© 2017
Gilstrap
J. S.
KD5TV

Tn
Color
TM

Chroma Rotary Phase™

Wide Screen Enhanced Definition WVGA 480i72 / 480p24 CRP™ for a 7mHz Channel Space

For the vertical scan a 3:1 interlace is used at a field rate of 72 Hz to produce the Film standard 24 frames per second. For the horizontal no sub-sampling will be used and the full refresh rate will also be at 24 frames per second, 41 $\frac{2}{3}$ ms. Using a 3:1 interlace at 72 Hz with 175 $\frac{1}{3}$ lines allows the use of a lower horizontal scan rate providing increased definition of the Luma channel and wider aspect ratio than the 4:3 definition image. Chroma Rotary Phase™ will be used instead of NTSC Chroma since its dot matrix pattern works better with the 3:1 interlace while still offering a two frame repeat pattern. With the increased Luma bandwidth this allows a higher Chroma sub-carrier frequency of 4.44mHz to be used. The sound is on a 5.75mHz sub-carrier that can handle 3 separate channels of audio, L+R, L-R, and SAP or Surround.

General:

Aspect Ratio	16:9 $\approx 1.\bar{7}$	Good Contrast
Total Picture Pixels (Digital)	853×480 ; 409440 Pixels	213:120 = 1.775
Kell Factor (Analog Resolution)	603×340 ; 204720 Pixels	852×480 ; 408960
		602×340 ; 204480

Vertical:

Frames Per Second	24 Hz [23.9799, -0.0838%]	(23.9991, -0.00379%)
Total Lines Per Frame	526 (2 Frame CRP™ Dot Repeat)	(23.9949, -0.0211%)
Fields Per Second	72 Hz [71.9397]	(71.9848) (71.9973)
Total Lines Per Field	175 $\frac{1}{3}$	
Picture Lines	160	
Lines Per Blank	15 $\frac{1}{3}$	
Blank	1.21 ms	
Sync	238 μ s ; 3 Lines	

Horizontal:

Resolution	Good:602	Max@-8dB:744
Lines Per Second	12.624 kHz [12.613425]	(12.621337) (12.623522)
Period (HP)	79.214 μ s (703)	
Picture	70.087 μ s (622)	
Total Picture Pixels	624 $\approx \phi \times \lambda_{BW} \times (HP-HB)$; (602+22) $\approx 3\frac{1}{2}\%$ Over Scan	
Viewable Picture Pixels	602 ; 67.616 μ s	
Blank (HB)	9.127 μ s (81)	
Front Porch	0.901 μ s (8)	
Sync	3.493 μ s (31)	
Back Porch	4.733 μ s (42)	

Luma & Chroma:

Luma (λ) Bandwidth @-3dB	5 $\frac{1}{2}$ mHz ; Vestigial $\frac{7}{8}$ mHz, Corner $\frac{1}{2}$ mHz	
Chroma:	Sub-Sampling 3 $\frac{1}{8}$:1: $\frac{1}{2}$	
Sub-Carrier	4.437336 mHz [PAL 4.43361875]	(4.4363999)
$\frac{1}{2}$ H Odd Harmonic	703 (351 $\frac{1}{2}$)	(4.437168)
Saturation Bandwidth	1 $\frac{3}{4}$ mHz (USB + $\frac{7}{8}$ mHz & LSB -1 $\frac{3}{4}$ mHz)	
Hue Bandwidth	$\frac{7}{8}$ mHz (USB + $\frac{7}{8}$ mHz & LSB - $\frac{7}{8}$ mHz)	
Color Burst Duration	2.704 μ s ; 12 cycles	2×(3 $\frac{1}{2}$ +12+5 $\frac{1}{2}$)=42
Baseband Guard	2 $\frac{5}{8}$ mHz	

Stereo Sound:

PM SubCarrier $\pm 157\frac{1}{2}^\circ \pm \frac{7}{8}\pi \pm 2\frac{3}{4}R$	5.794416 mHz [5.7895619]	(5.7931936) (5.7941966)
H Harmonic	459	
L & R Frequency Response	L+R 50Hz-15kHz, L-R 125Hz-15kHz	
Equalization	75 μ s Pre-Emphasis, Shelf at 12.73kHz (12 $\frac{1}{2}$ μ s)	
Harmonic Peak Shifting	65 μ s & 650 μ s Phase Shift Networks (Optional)	
L-R Sub-Carrier 3×H	37.872 kHz [37.840274]	(37.864011) (37.870566)
Modulation	Unlimited Armstrong PM $\pm 74^\circ$, Peak Q:I=3 $\frac{1}{2}$	
	Compander Controlled 'I' Channel	

The next page is a 848×480 test pattern.

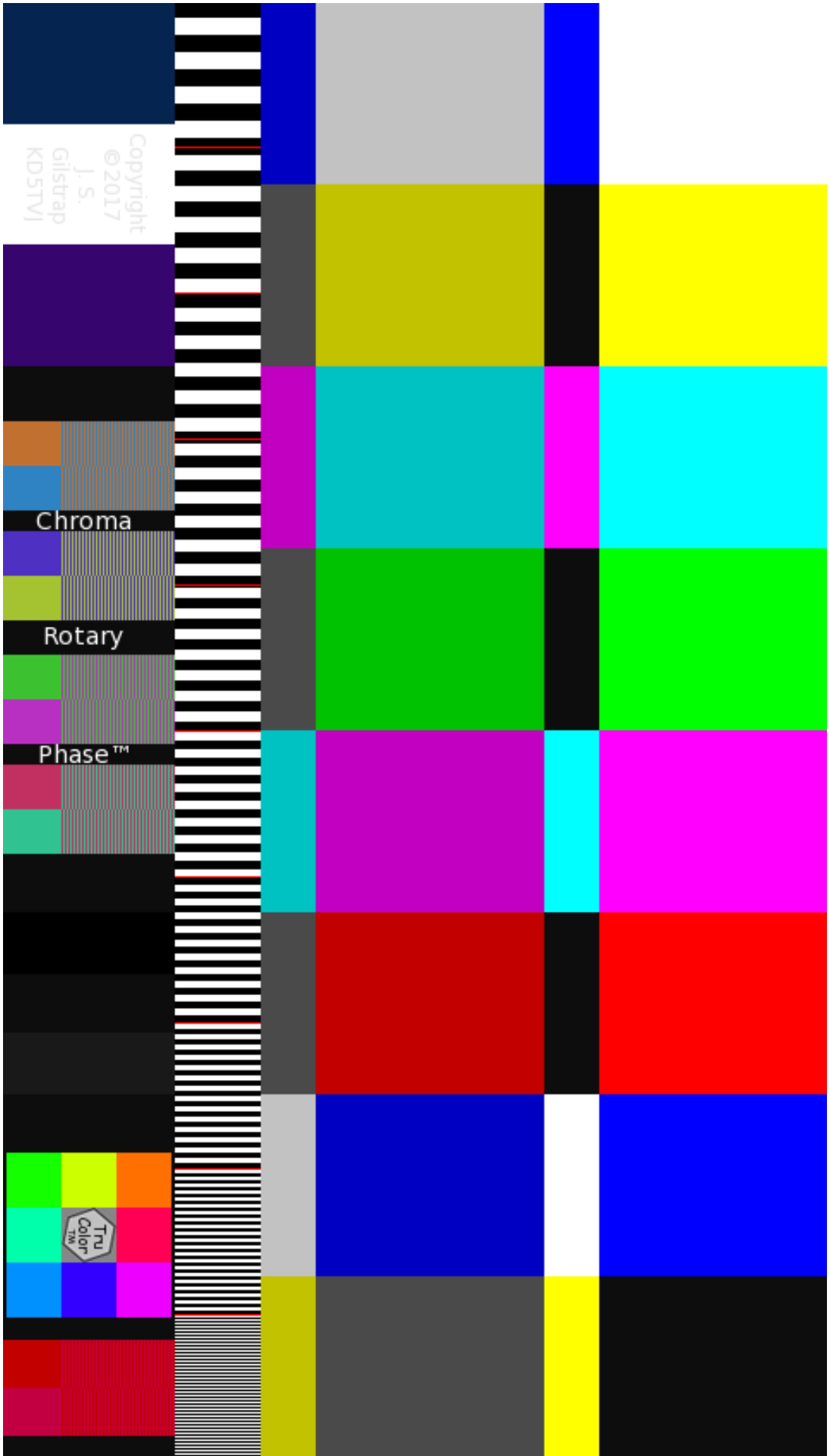

Copyright © 2017
J. S. Gilstrap
KD5TV

Chroma

Rotary

Phase™

TM
Color™

Wider Aspect Enhanced Definition wVGA 528i72 / 528p24 CRP™ for a 7mHz Channel Space

For the vertical scan a 3:1 interlace is used at a field rate of 72 Hz to produce the Film standard 24 frames per second. For the horizontal no sub-sampling will be used and the full refresh rate will also be at 24 frames per second, 41 $\frac{2}{3}$ ms. Using a 3:1 interlace at 72 Hz with 195 $\frac{1}{3}$ lines allows the use of a slightly lower horizontal scan rate providing increased definition of the Luma channel and an aspect ratio just slightly wider than 4:3. Chroma Rotary Phase™ will be used instead of NTSC Chroma since its dot matrix pattern works better with the 3:1 interlace while still offering a two frame repeat pattern. With the increased Luma bandwidth this allows a higher Chroma sub-carrier frequency of 4.44mHz to be used. The sound is on a 5.75mHz sub-carrier that can handle 3 separate channels of audio, L+R, L-R, and SAP or Surround.

General:

		Good Contrast
Aspect Ratio	3:2 = 1 $\frac{1}{2}$	47:33 = 1. $\overline{42}$
Total Picture Pixels (Digital)	792×528 ; 447744 Pixels	752×528 ; 397056
Kell Factor (Analog Resolution)	600×373 ; 223872 Pixels	532×373 ; 198528

Vertical:

		(23.9999, -0.00054%)
Frames Per Second	24 Hz [23.9807, -0.0805%]	(23.9957, -0.01785%)
Total Lines Per Frame	586 (2 Frame CRP™ Dot Repeat)	
Fields Per Second	72 Hz [71.942]	(71.9871) (71.9996)
Total Lines Per Field	195 $\frac{1}{3}$	
Picture Lines	176	
Lines Per Blank	19 $\frac{1}{3}$	
Blank	1.3747 ms	
Sync	213 μ s ; 3 Lines	

Horizontal:

		Resolution Good:532 Max@-8dB:647
Lines Per Second	14.064 kHz [14.052674]	(14.061489) (14.063924)
Period (HP)	71.104 μ s (631)	
Total Picture Period	61.976 μ s (550)	
Total Picture Pixels	552 $\approx \phi \times \lambda_{BW} \times (HP-HB)$; (532+20) $\approx 3\frac{5}{8}\%$ Over Scan	
Viewable Picture	524 ; 59.78 μ s	
Blank (HB)	9.127 μ s (81)	
Front Porch	0.901 μ s (8)	
Sync	3.493 μ s (31)	
Back Porch	4.733 μ s (42)	



Luma & Chroma:

Luma (λ) Bandwidth @-3dB	5 $\frac{1}{2}$ mHz ; Vestigial $\frac{7}{8}$ mHz, Corner $\frac{1}{2}$ mHz	
Chroma:	Sub-Sampling 3 $\frac{1}{8}$:1: $\frac{1}{2}$	
Sub-Carrier	4.437192 mHz [PAL 4.43361875]	(4.4363999)
$\frac{1}{2}$ H Odd Harmonic	631 (315 $\frac{1}{2}$)	(4.437168)
Saturation Bandwidth	1 $\frac{3}{4}$ mHz (USB + $\frac{7}{8}$ mHz & LSB -1 $\frac{3}{4}$ mHz)	
Hue Bandwidth	$\frac{7}{8}$ mHz (USB + $\frac{7}{8}$ mHz & LSB - $\frac{7}{8}$ mHz)	
Color Burst Duration	2.704 μ s ; 12 cycles $2 \times (3\frac{1}{2} + 12 + 5\frac{1}{2}) = 42$	
Baseband Guard	2 $\frac{5}{8}$ mHz	

Stereo Sound:

PM SubCarrier $\pm 157\frac{1}{2}^\circ \pm \frac{7}{8}\pi \pm 2\frac{3}{4}R$	5.794368 mHz [5.7897018]		(5.7933336) (5.7943367)
H Harmonic	412		
L & R Frequency Response	L+R 50Hz-15kHz, L-R 125Hz-15kHz		
Equalization	75 μ s Pre-Emphasis, Shelf at 12.73kHz (12 $\frac{1}{2}$ μ s)		
Harmonic Peak Shifting	65 μ s & 650 μ s Phase Shift Networks (Optional)		
L-R Sub-Carrier 3×H	42.192 kHz [42.158023]		(42.184468) (42.191177)
Modulation	Unlimited Armstrong PM $\pm 74^\circ$, Peak Q:I=3 $\frac{1}{2}$		
	Compander Controlled 'I' Channel		

The next page is a 792×528 color bar image.



Wide Screen Enhanced Definition WVGA 528i72 / 528p24 CRP™ for an 8MHz Channel Space

For the vertical scan a 3:1 interlace is used at a field rate of 72 Hz to produce the Film standard 24 frames per second. For the horizontal no sub-sampling will be used and the full refresh rate will also be at 24 frames per second, 41 $\frac{2}{3}$ ms. Using a 3:1 interlace at 72 Hz with 195 $\frac{1}{3}$ lines allows the use of a slightly lower horizontal scan rate providing some increased definition of the Luma channel and wider aspect ratio than the 4:3 definition image. Chroma Rotary Phase™ will be used instead of PAL Chroma since its dot matrix pattern works better with the 3:1 interlace while still offering a two frame repeat pattern but 4.44MHz Chroma sub-carrier frequency will be used. The sound is on a 6.75 MHz sub-carrier that can handle 3 separate channels of audio, L+R, L-R, and SAP or Surround.

General:

		Good Contrast
Aspect Ratio	5:3 $\approx 1.\bar{6}$	219:132 = 1.6591
Total Picture Pixels (Digital)	880x528 ; 464640 Pixels	876x528 ; 462528
Kell Factor (Analog Resolution)	622x373 ; 232320 Pixels	620x373 ; 231264

Vertical:

		(23.9999, -0.00054%)
Frames Per Second	24 Hz [23.9807, -0.0805%]	(23.9957, -0.01785%)
Total Lines Per Frame	586 (2 Frame CRP™ Dot Repeat)	
Fields Per Second	72 Hz [71.942]	(71.9871) (71.9996)
Total Lines Per Field	195 $\frac{1}{3}$	
Picture Lines	176	
Lines Per Blank	19 $\frac{1}{3}$	
Blank	1.3747 ms	
Sync	213 μ s ; 3 Lines	

Horizontal:

	Resolution Good:620 Max@-8dB:766
Lines Per Second	14.064 kHz [14.052674] (14.061489) (14.063924)
Period (HP)	71.104 μ s (631)
Picture	61.976 μ s (550)
Total Picture Pixels	642 $\approx \phi \times \lambda_{BW} \times (HP - HB)$; (620+22) $\approx 3\frac{2}{5}\%$ Over Scan
Viewable Picture	620 ; 59.85 μ s
Blank (HB)	9.127 μ s (81)
Front Porch	0.901 μ s (8)
Sync	3.493 μ s (31)
Back Porch	4.733 μ s (42)

Luma & Chroma:

Luma (λ) Bandwidth @-3dB	6 $\frac{2}{5}$ MHz ; Vestigial 1mHz, Corner $\frac{5}{8}$ MHz
Chroma:	Sub-Sampling 3 $\frac{2}{3}$:1:1
Sub-Carrier	4.437192 MHz [4.43361875 PAL B,D,G,H,I,K]
$\frac{1}{2}$ H Odd Harmonic	631 (315 $\frac{1}{2}$) (4.437168) (4.4363999)
U Bandwidth	1 $\frac{3}{4}$ MHz (USB +1 $\frac{3}{4}$ mHz & LSB -1 $\frac{3}{4}$ mHz)
V Bandwidth	1 $\frac{3}{4}$ MHz (USB +1 $\frac{3}{4}$ mHz & LSB -1 $\frac{3}{4}$ mHz)
Color Burst Duration	2.704 μ s ; 12 cycles $2 \times (3\frac{1}{2} + 12 + 5\frac{1}{2}) = 42$
Baseband Guard	2 $\frac{5}{8}$ MHz

Stereo Sound:

PM SubCarrier $\pm 157\frac{1}{2}^\circ \pm \frac{7}{8}\pi \pm 2\frac{3}{4}R$	6.75072 MHz [6.7452837] (6.7495149) (6.7506835)
H Harmonic	480
L & R Frequency Response	L+R 50Hz-15kHz, L-R 125Hz-15kHz
Equalization	75 μ s Pre-Emphasis, Shelf at 12.73kHz (12 $\frac{1}{2}$ μ s)
Harmonic Peak Shifting	65 μ s & 650 μ s Phase Shift Networks (Optional)
L-R Sub-Carrier 3xH	42.192 kHz [42.158023] (42.184468) (42.191177)
Modulation	Unlimited Armstrong PM $\pm 74^\circ$, Peak Q:I=3 $\frac{1}{2}$ Comander Controlled 'I' Channel

Wider Screen Enhanced Definition EGA 576i72 / 576p24 CRP™ for an 8MHz Channel Space

For the vertical scan a 3:1 interlace is used at a field rate of 72 Hz to produce the Film standard 24 frames per second. For the horizontal no sub-sampling will be used and the full refresh rate will also be at 24 frames per second, 41 $\frac{2}{3}$ ms. Using a 3:1 interlace at 72 Hz with 211 $\frac{1}{3}$ lines allows the use of a slightly lower horizontal scan rate providing some increased definition of the Luma channel and wider aspect ratio than the 4:3 definition image. Chroma Rotary Phase™ will be used instead of PAL Chroma since its dot matrix pattern works better with the 3:1 interlace while still offering a two frame repeat pattern but the old 4.44MHz Chroma sub-carrier frequency will be used. The sound is on a 6.75 mHz sub-carrier that can handle 3 separate channels of audio, L+R, L-R, and SAP or Surround.

General:

		Good Contrast
Aspect Ratio	33:24 = 1 $\frac{3}{8}$	33:24 = 1 $\frac{3}{8}$
Total Picture Pixels (Digital)	792×576 ; 551072 Pixels	792×576 ; 456192
Kell Factor (Analog Resolution)	560×407 ; 265536 Pixels	560×407 ; 228096

Vertical:

		(24.0092, +0.0384%)
Frames Per Second	24 Hz [23.99, -0.0416%]	(24.0051, +0.0211%)
Total Lines Per Frame	634 (2 Frame CRP™ Dot Repeat)	
Fields Per Second	72 Hz [71.97] (72.0152) (72.0277)	
Total Lines Per Field	211 $\frac{1}{3}$	
Picture Lines	192	
Lines Per Blank	19 $\frac{1}{3}$	
Blank	1.2711 ms	
Sync	197 μs ; 3 Lines	

Horizontal:

	Resolution Good:560 Max@-8dB:692	
Lines Per Second	15.216 kHz [15.20967] (15.219211) (15.221846)	
Period (HP)	65.720 μs (583)	
Picture	56.589 μs (502)	
Total Picture Pixels	586 ≈ φ × λ _{BW} × (HP-HB) ; (560+26) ≈ 4 $\frac{2}{3}$ % OverScan	
Viewable Picture	560 ; 54.078 μs	
Blank (HB)	9.131 μs (81)	
Front Porch	0.902 μs (8)	
Sync	3.495 μs (31)	
Back Porch	4.735 μs (42)	

Luma & Chroma:

Luma (λ) Bandwidth @-3dB	6 $\frac{2}{3}$ mHz ; Vestigial 1mHz, Corner $\frac{5}{8}$ mHz	
Chroma:	Sub-Sampling 3 $\frac{2}{3}$:1:1	
Sub-Carrier	4.435464 mHz [4.43361875 PAL B,D,G,H,I,K]	
$\frac{1}{2}$ H Odd Harmonic	583 (291 $\frac{1}{2}$) (4.437168) (4.4363999)	
U Bandwidth	1 $\frac{3}{4}$ mHz (USB +1 $\frac{3}{4}$ mHz & LSB -1 $\frac{3}{4}$ mHz)	
V Bandwidth	1 $\frac{3}{4}$ mHz (USB +1 $\frac{3}{4}$ mHz & LSB -1 $\frac{3}{4}$ mHz)	
Color Burst Duration	2.705 μs ; 12 cycles 2×(3 $\frac{1}{2}$ +12+5 $\frac{1}{2}$)=42	
Baseband Guard	2 $\frac{5}{8}$ mHz	

Stereo Sound:

PM SubCarrier ±157 $\frac{1}{2}$ ° ± $\frac{7}{8}$ π ±2 $\frac{3}{4}$ R	6.755904 mHz [6.7530934] (6.7573282) (6.7584995)	
H Harmonic	444	
L & R Frequency Response	L+R 50Hz-15kHz, L-R 125Hz-15kHz	
Equalization	75μs Pre-Emphasis, Shelf at 12.73kHz (12 $\frac{1}{2}$ μs)	
Harmonic Peak Shifting	65μs & 650μs Phase Shift Networks (Optional)	
L-R Sub-Carrier 3×H	45.648 kHz [45.629009] (45.657632) (45.665537)	
Modulation	Unlimited Armstrong PM ±74°, Peak Q:I=3 $\frac{1}{2}$	
	Compander Controlled 'I' Channel	

The next page is a 768×576 test pattern.

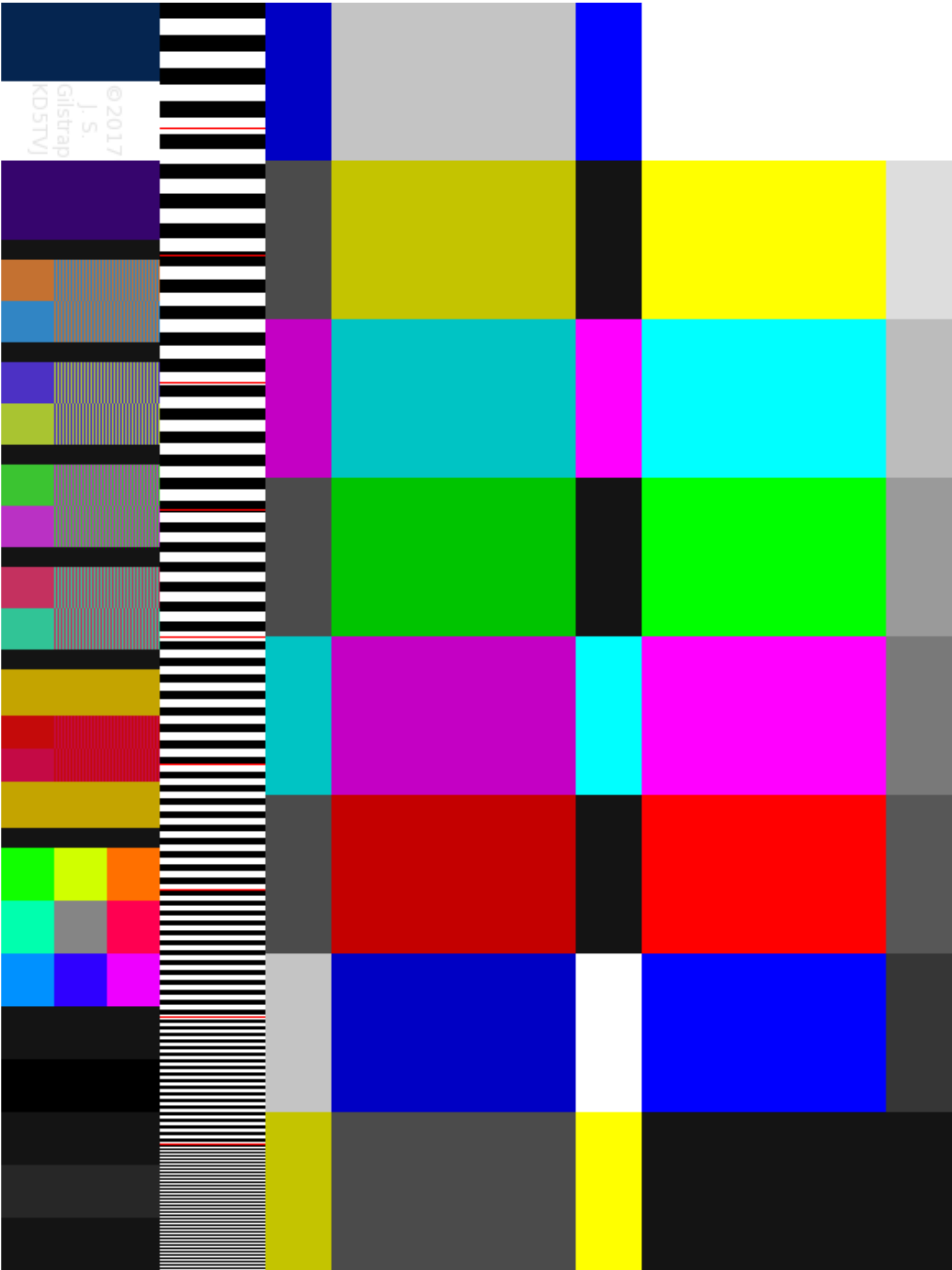

Wide Screen High Definition WXGA 816i72 / 816p24 CRP™ for an 8mHz Channel Space

For the vertical scan a 3:1 interlace is used at a field rate of 72 Hz with $299\frac{1}{3}$ lines to produce the Film standard 24 frames per second, $41\frac{2}{3}$ ms. For the horizontal scan a 4:1 pixel interlaced sub-nyquist sampling is used to almost triple the Luma resolution, à la MUSE Hi-Vision. Below is a rough layout of the specification. It takes $\frac{1}{6}$ of a second (166ms), 4 full frames (12 fields) to receive the full high definition image. A frame buffer is used to store the 4 frames to assemble a full resolution still picture. For motion the 72 Hz field rate will provide a reduced resolution de-interlaced image with motion blur every $13.\bar{8}$ ms. Chroma Rotary Phase™ with a 5.1 mHz sub-carrier frequency will be used since its dot matrix pattern works better with the 3:1 interlace while still offering a two frame repeat pattern. The sound is on a 6.75 mHz sub-carrier that can handle 3 separate channels of audio, L+R, L-R, and SAP or Surround.

General:

Aspect Ratio	16:9	≈ 1.765
Total Picture Pixels (Digital)	1440×816	; 1175040 Pixels
Kell Factor (Analog Resolution)	1018×577	; 587520 Pixels
Sub-Nyquist(x) & Interlace(y)	360×272	(4:1 & 3:1)

Vertical:

Frames Per Second	24 Hz
Total Lines Per Frame	898 (2 Frame CRP™ Dot Repeat)
Fields Per Second	72 Hz
Total Lines Per Field	$299\frac{1}{3}$
Picture Lines	272
Lines Per Blank	$27\frac{1}{3}$
Blank	1.268 ms
Sync	186 μs ; 4 Lines

Horizontal:

	Resolution Good:366	Max@-8dB:452
Freq, Period (H _p), Clock Pixel/Lines	21.552 kHz,	46.3994 μs, 473
Picture BW Pixels	$379 \approx \phi \times \lambda_{BW} \times (H_p - H_b)$; (360+19)≈5% OverScan	
Total Picture Clock ; Period	379 ;	37.178 μs
Blank (H _b)	94 ;	9.221 μs
Front Porch	10 ;	0.981 μs
Sync	36 ;	3.531 μs
Back Porch	48 ;	4.709 μs

Luma & Chroma:

Luma (λ) Bandwidth @-3dB	$6\frac{2}{3}$ mHz ; Vestigial 1mHz, Corner $\frac{5}{8}$ mHz
Chroma:	Sub-Sampling $5\frac{7}{8}:1:\frac{2}{3}$
Sub-Carrier	5.097048 mHz
$\frac{1}{2}$ H Odd Harmonic	473 (236 $\frac{1}{2}$)
Saturation Bandwidth	3mHz (USB +1 $\frac{1}{4}$ mHz & LSB -3 mHz)
Hue Bandwidth	1 $\frac{1}{4}$ mHz (USB +1 $\frac{1}{4}$ mHz & LSB -1 $\frac{1}{4}$ mHz)
Color Burst Duration	2.747 μs ; 14 cycles 2×(4+14+6)=48
Baseband Guard	2 mHz

Stereo Sound:

PM SubCarrier $\pm 157\frac{1}{2}^\circ \pm \frac{7}{8}\pi \pm 2\frac{3}{4}R$	6.745776 mHz
H Harmonic	313
L & R Frequency Response	L+R 50Hz-15kHz, L-R 125Hz-15kHz
Equalization	75μs Pre-Emphasis, Shelf at 12.73kHz (12 $\frac{1}{2}$ μs)
Harmonic Peak Shifting	65μs & 650μs Phase Shift Networks (Optional)
L-R Sub-Carrier 2×H	43.104 kHz
Modulation	Unlimited Armstrong PM $\pm 74^\circ$, Peak Q:I=3 $\frac{1}{2}$ Compander Controlled 'I' Channel

Wide Screen High Definition WXGA 768i72 / 768p24 CRP™ for an 7mHz Channel Space

For the vertical scan a 3:1 interlace is used at a field rate of 72 Hz with $283\frac{1}{3}$ lines to produce the Film standard 24 frames per second, $41\frac{2}{3}$ ms. For the horizontal scan a 4:1 pixel interlaced sub-nyquist sampling is used to almost triple the Luma resolution, à la MUSE Hi-Vision. Below is a rough layout of the specification. It takes $\frac{1}{6}$ of a second (166ms), 4 full frames (12 fields) to receive the full high definition image. A frame buffer is used to store the 4 frames to assemble a full resolution still picture. For motion the 72 Hz field rate will provide a reduced resolution de-interlaced image with motion blur every $13.\bar{8}$ ms. Chroma Rotary Phase™ with a 4.44 mHz sub-carrier frequency will be used since its dot matrix pattern works better with the 3:1 interlace while still offering a two frame repeat pattern. The sound is on a 5.8 mHz sub-carrier that can handle 3 separate channels of audio, L+R, L-R, and SAP or Surround.

General:

Aspect Ratio	7:4 = $1\frac{3}{4}$	Stretch to:	16:9 = 1.7
Total Picture Pixels (Digital)	1344x768 ; 1032192 Pixels		1366:768 ; 1049088
Kell Factor (Analog Resolution)	950x543 ; 516096 Pixels		965:543 ; 524544
Sub-Nyquist(x) & Interlace(y)	336x256 (4:1 & 3:1)		

Vertical:

Frames Per Second	24 Hz [23.9817, -0.0762%]	(24.0009, +0.0038%)
Total Lines Per Frame	850 (2 Frame CRP™ Dot Repeat)	(23.9968, -0.01352%)
Fields Per Second	72 Hz [71.9451]	(71.9903) (72.0027)
Total Lines Per Field	$283\frac{1}{3}$	
Picture Lines	256	
Lines Per Blank	$27\frac{1}{3}$	
Blank	1.34 ms	
Sync	186 μ s ; 4 Line	

Horizontal:

Resolution	Good:337 Max@-8dB:416
Freq, Period (H _p), Clock Pixel/Lines	20.4 kHz, 49.0196 μ s, 435 [20.384454]
Picture BW Pixels	$354 \approx \phi \times \lambda_{BW} \times (H_p - H_b)$; (336+18) \approx 5% (20.397241)
Total Picture Clock ; Period	354 ; 39.892 μ s OverScan (20.400772)
Blank (H _b)	81 ; 9.128 μ s
Front Porch	8 ; 0.902 μ s
Sync	31 ; 3.493 μ s
Back Porch	42 ; 4.733 μ s

Luma & Chroma:

Luma (λ) Bandwidth @-3dB	$5\frac{1}{2}$ mHz ; Vestigial $\frac{7}{8}$ mHz, Corner $\frac{1}{2}$ mHz
Chroma:	Sub-Sampling $5\frac{5}{8}:1:\frac{1}{3}$
Sub-Carrier	4.437 mHz [PAL 4.43361875] (4.4363999)
$\frac{1}{2}$ H Odd Harmonic	435 (217 $\frac{1}{2}$) (4.437168)
Saturation Bandwidth	$2\frac{3}{4}$ mHz (USB $+\frac{7}{8}$ mHz & LSB $-2\frac{3}{4}$ mHz)
Hue Bandwidth	$\frac{7}{8}$ mHz (USB $+\frac{7}{8}$ mHz & LSB $-\frac{7}{8}$ mHz)
Color Burst Duration	2.68 μ s ; 12 cycles $2 \times (3\frac{1}{2} + 12 + 5\frac{1}{2}) = 42$
Baseband Guard	$1\frac{1}{2}$ mHz

Stereo Sound:

PM SubCarrier $\pm 157\frac{1}{2}^\circ \pm \frac{7}{8}\pi \pm 2\frac{3}{4}R$	5.7936 mHz [5.7891849] (5.7928164) (5.7938194)
H Harmonic	284
L & R Frequency Response	L+R 50Hz-15kHz, L-R 125Hz-15kHz
Equalization	75 μ s Pre-Emphasis, Shelf at 12.73kHz (12 $\frac{1}{2}$ μ s)
Harmonic Peak Shifting	65 μ s & 650 μ s Phase Shift Networks (Optional)
L-R Sub-Carrier 2xH	40.8 kHz [40.768908] (40.794482) (40.801545)
Modulation	Unlimited Armstrong PM $\pm 74^\circ$, Peak Q:I=3 $\frac{1}{2}$ Compander Controlled 'I' Channel

Wide Screen High Definition WXGA 672i72 / 672p24 CRP™ for a 6mHz Channel Space

For the vertical scan a 3:1 interlace is used at a field rate of 72 Hz to produce the Film standard 24 frames per second. For the horizontal scan a 4:1 pixel interlaced sub-nyquist sampling is used to almost triple the Luma resolution, à la MUSE Hi-Vision. Below is a rough layout of the specification. It takes $\frac{1}{6}$ of a second (166ms), 4 full frames (12 fields) to receive the full high definition image. A frame buffer is used to store the 4 frames to assemble a full resolution still picture. For motion the 72 Hz field rate will provide a reduced resolution de-interlaced image with motion blur every $13.\bar{8}$ ms. Chroma Rotary Phase™ will be used instead of NTSC Chroma since its dot matrix pattern works better with the 3:1 interlace while still offering a two frame repeat pattern but a 3.57mHz Chroma sub-carrier frequency will be used. The vestigial sideband has been reduced by $\frac{3}{8}$ mHz to increase Luma bandwidth to $4\frac{1}{2}$ mHz. The sound is on a 4.8 mHz sub-carrier that can handle 3 separate channels of audio, L+R, L-R, and SAP or Surround.

General:

Aspect Ratio	53:28 = 1.89285714
Total Picture Pixels (Digital)	1272×672 ; 854784 Pixels
Kell Factor (Analog Resolution)	899×475 ; 427392 Pixels
Sub-Nyquist(x) & Interlace(y)	318×224 (4:1 & 3:1)

Vertical:

	[24.0608, +0.253%] (24.0282, +0.11756%)
Frames Per Second	24 Hz [24.0343, +0.143%]
Total Lines Per Frame	742 (2 Frame CRP™ Dot Repeat)
Fields Per Second	72 Hz [72.103] [72.1823] (72.0846)
Total Lines Per Field	247 $\frac{1}{3}$
Picture Lines	224
Lines Per Blank	23 $\frac{1}{3}$
Blank	1.31 ms
Sync	225 μs ; 4 Lines

Horizontal:

	Resolution Good:324 Max@-8dB:401
Freq, Period (H _P), Clock Pixel/Line	17.808 kHz, 56.155 μs, 401 [17.833471] [17.853092]
Picture BW Pixels	335 ≈ 1 $\frac{3}{5}$ × λ _{BW} × (H _P -H _B) ; (318+17)≈5% OverScan
Total Picture Clock ; Period	335 ; 46.912 μs (17.828935)
Blank (H _B)	66 ; 9.242 μs
Front Porch	7 ; 0.980 μs
Sync	25 ; 3.501 μs
Back Porch	34 ; 4.761 μs

Luma & Chroma:

Luma (λ) Bandwidth @-3dB	4 $\frac{1}{2}$ mHz ; Vestigial $\frac{7}{8}$ mHz, Corner $\frac{1}{2}$ mHz
Chroma:	Sub-Sampling 6 $\frac{1}{4}$:1: $\frac{1}{2}$
Sub-Carrier	3.570504 mHz [3.575611 PAL-M] (3.5747015)
$\frac{1}{2}$ H Odd Harmonic	401 (200 $\frac{1}{2}$) [3.579545 NTSC]
Saturation Bandwidth	2 mHz (USB + $\frac{7}{8}$ mHz & LSB -2mHz)
Hue Bandwidth	$\frac{7}{8}$ mHz (USB + $\frac{7}{8}$ mHz & LSB - $\frac{7}{8}$ mHz)
Color Burst Duration	2.801 μs ; 10 cycles 2×(2 $\frac{3}{4}$ +10+4 $\frac{1}{4}$)=34
Baseband Guard	1 $\frac{1}{2}$ mHz

Stereo Sound:

PM SubCarrier ±157 $\frac{1}{2}$ ° ± $\frac{7}{8}$ π ±2 $\frac{3}{4}$ R	4.790352 mHz [4.7972038] [4.8024818] (4.7959836)
H Harmonic	269
L & R Frequency Response	L+R 50Hz-15kHz, L-R 125Hz-15kHz
Equalization	75μs Pre-Emphasis, Shelf at 12.73kHz (12 $\frac{1}{2}$ μs)
Harmonic Peak Shifting	65μs & 650μs Phase Shift Networks (Optional)
L-R Sub-Carrier 2×H	35.616 kHz [35.666943] [35.706185] (35.658005)
Modulation	Unlimited Armstrong PM ±74°, Peak Q:I=3 $\frac{1}{2}$ Compander Controlled 'I' Channel

A Simpler Phase Rotation Method

In referring to the vector chart on page 6 it can be seen that rotating the **U & V** signals by 90° every line causes the **I & Q** signals to flip 180° every other line at half the rate of **U & V** 90° step rotation and the **I & Q** flips are offset by one line to each other. Both **U & V** and **I & Q** signals will rotate a full 360° over 4 lines but **U & V** do it in 4 steps at 90° each whereas **I & Q** do it in 2 steps at 180° each. In a simpler approach to encoding instead of matrixing into **U & V** and rotating both by 90° per line, matrix the **Chroma** into **I & Q** and flip each one every other line. Line A to B flip **I**, line B to C flip **Q**, line C to D unflip **I**, line D to A unflip **Q**. The page 6 chart also shows that subtracting two adjacent lines to eliminate the **Luma** produces **I** or **Q** signals, not **U** or **V**. If high and low bandwidth signals are used for **I & Q** respectively this can be used to an advantage during the encode/decode process.

Originally during NTSC color TV development it was believed that the **I/Q** high/low bandwidth scheme was necessary when using a quadrature vestigial sideband signal since both sidebands are needed for full quadrature channel separation. This is true if the two signals are completely independent from each other but the **Chroma** signal characteristics are a polar defined structure of **Saturation** and **Hue** as **R** and θ that is represented in the Cartesian coordinate state within the **U & V** signals making them interrelated and in practice full frequency channel separation has not proven to be an issue with a vestigial sideband. Using a vestigial sideband with a quadrature signal in this case can be addressed as the low bandwidth double sideband portion being used for **Saturation** and **Hue** while the higher bandwidth extended lower sideband is used to enhance sharpness for **Saturation** changes. An enhanced version of this could be to take the phase of the lower bandwidth quadrature **Hue** portion of the signal and modulate it to carry the envelope of the full bandwidth quadrature **Chroma** saturation signal supported by the extended lower sideband only much the same way that is used for the vestigial sideband **Luma** signal. Using a differential bandwidth scheme for **I & Q** signals does not provide as great a benefit for the extra complexity required compared to the high/low bandwidth **Saturation/Hue** scheme.

With this in mind using a differential bandwidth for **I & Q** signals is not really needed as it once was thought. When the **U & V** signals are the desired output from line combining then swapping **I & Q** for **V & U** respectively in using the 180° flip process will output **U & V** when lines are combined and would be the preferable method. Line A to B flip **U**, line B to C flip **V**, line C to D unflip **U**, line D to A unflip **V**. This also causes the **I & Q** signals to rotate 90° per line in opposite directions not **U & V** as in the previous method. Rotation may also produce some sideband asymmetry and if this is significant it would be desirable to have '**I**' rotate in the direction that would produce stronger lower sideband energy. The chart below shows this alternate method in the electrical domain, but not on screen. On screen **I & Q** will rotate in opposite directions in relation to the electrical domain when the **Chroma** sub-carrier ends each line with $\frac{1}{2}$ cycle. The previous ColorBurst signaling phases can be used or a more sophisticated method where the ColorBurst phase is aligned with the '**+I**' vector and would rotate a full 360° through the 4 states of phase rotation. This would also require a

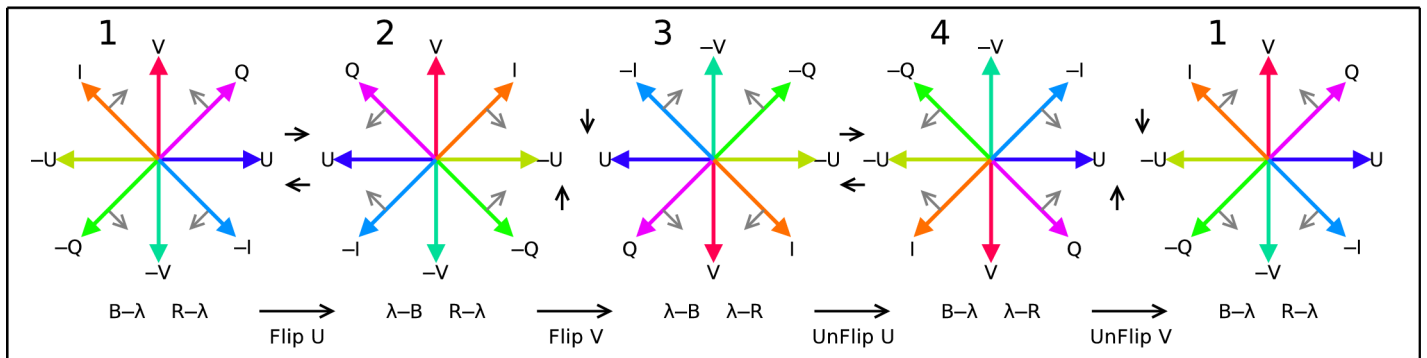

more sophisticated switching PLL loop filter that would compensate for the rotation. A better approach would be a 4 angle ColorBurst signal with easy PLL tracking that would also identify proper switch states for both **U & V** axes, one with separate switching signals from the ColorBurst signal on each of the **U & V** axes, e.g. 1:155°, 2:125°, 3:235°, 4:205°.

The 180° axes flip that produces indirect instead of using direct 90° vector rotation is similar to PAL but both axes are flipped electrically, (PAL 2.0™, PAL 2™, PAL 2x™ or DualPAL™ anyone?), producing both electrical and on screen vector rotation while still using the $\frac{1}{2}$ cycle/line offset maintaining a dot pattern similar to NTSC. PAL (Der System Bruch)

using $\frac{3}{4}||\frac{1}{4}$ cycle/line offset to shift both axes 90° on screen also incorporated phase creep to fix the broken Chroma dot pattern that the $\frac{1}{2}$ cycle/line 180° offset NTSC created. This 90° shift per line on screen of both **U** & **V** vectors is in the same direction but switching **V**'s polarity at the H/2 rate reverses its rotational shift in relation to **U** on screen. As a result in relation to the beginning of each line on screen both **U** & **V** shift 90° per line in opposite directions which causes **U** & **V** to swap axes. Any hue phase errors will be in the opposite direction on alternate lines canceling out any errors.

With this alternative method the on screen Chroma color dot patterns on page 10 will swap colors between **V** & **U** and **I** & **Q** positions respectively. In the electrical domain with both rotating clockwise '**I**' will swap with '**V**' and rotating counter-clockwise '**Q**' will swap with '**U**', swapping Orange and Red, CyanBlue and Cyan, Magenta and Blue, Green and Yellow.

I, Q, V, U, & Composite flip switch dot patterns.

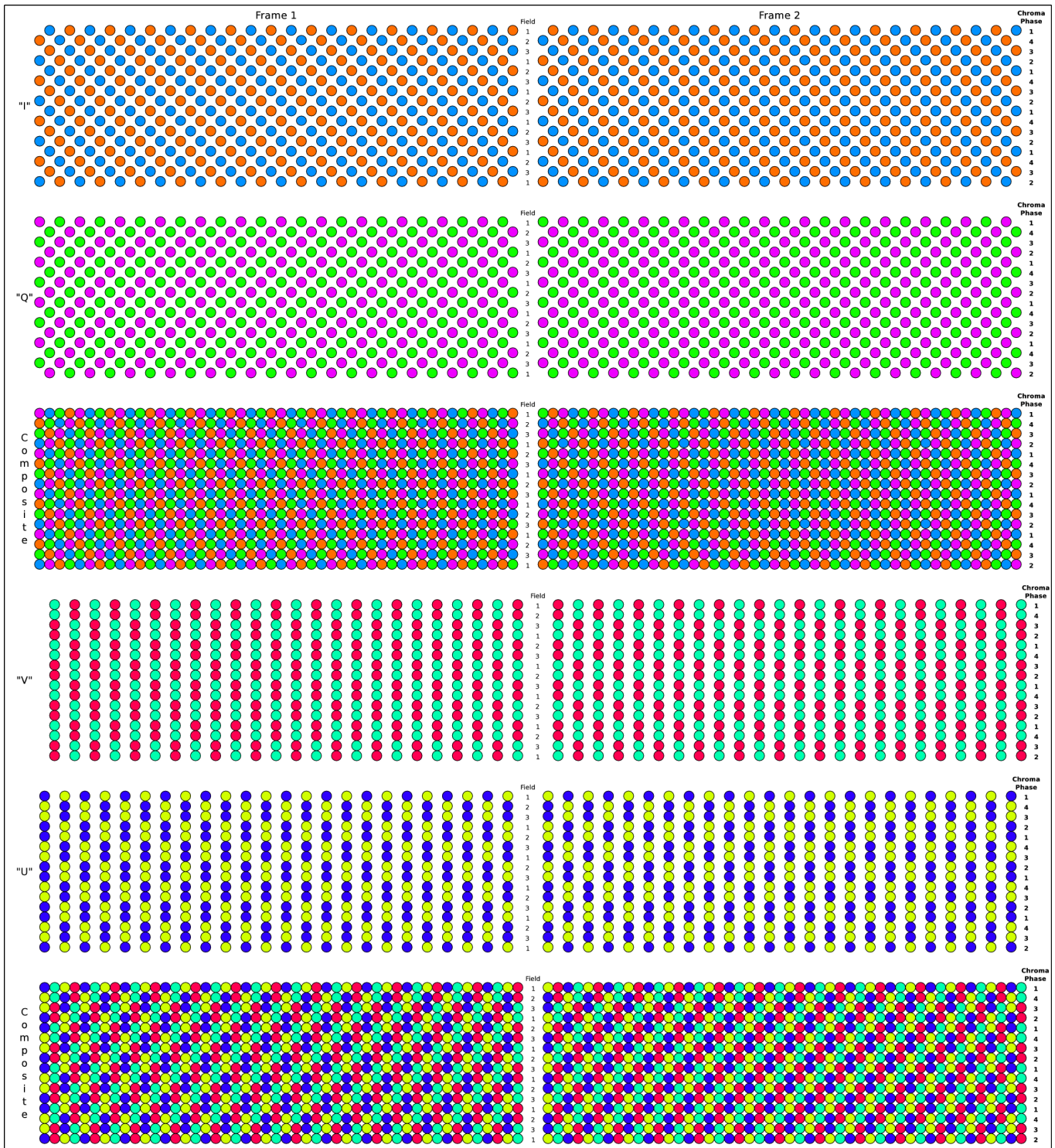

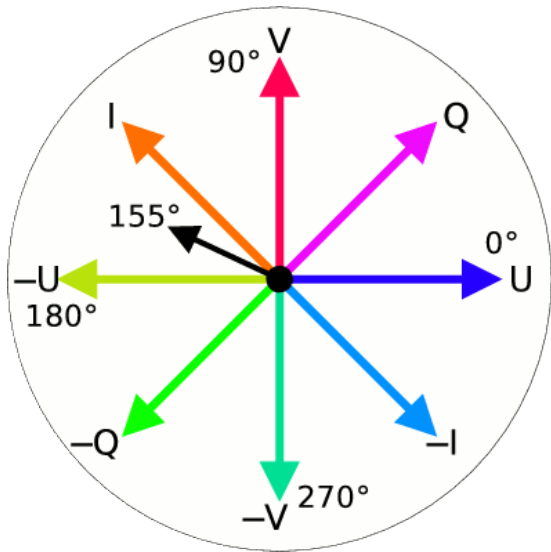

Chroma Rotary Phase
U & V Flip Switch Animation

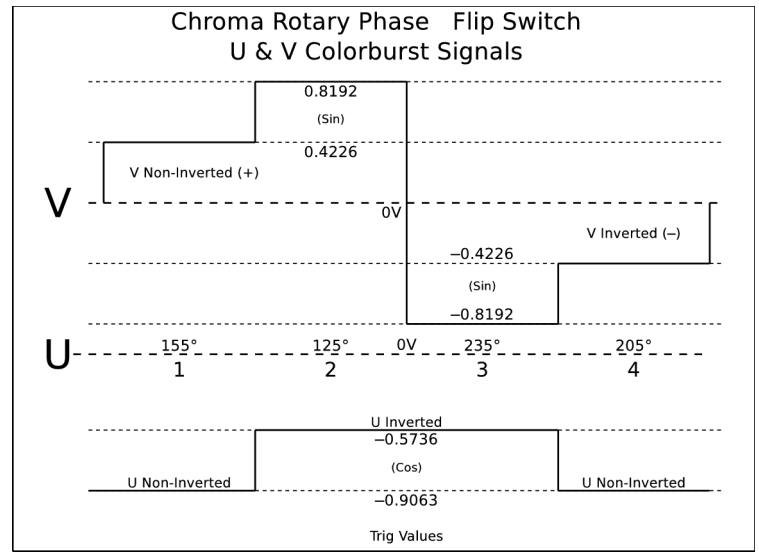

U & V Flip Switch Colorburst signaling.

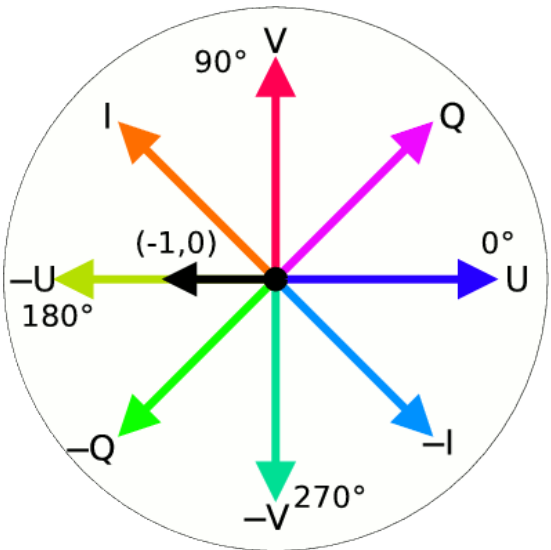

Chroma Rotary Phase
U & V Vector Rotation Animation

This document being in PDF format does not support animated images. For access to these and other live animations in ODT format please follow this link below.
[NATV Animations](#)

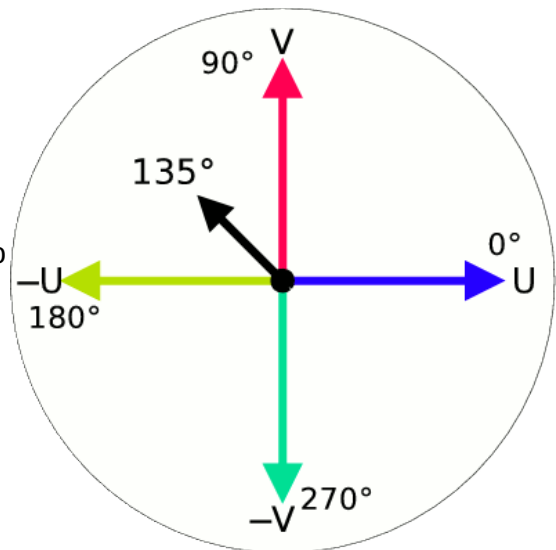

PAL On Screen Vector Rotation & Vswitch Animation

For transmission using a fully suppressed carrier for the composite video, not including sync (zero carrier modulation by Luma at 50% gray, or a content variable level carrier to maximize carrier suppression on a per frame basis, with synchronous detection of the 'I' channel will greatly improve transmitter efficiency and signal reception integrity. Only the ColorBurst, color modulation and Sync pulses will rise above the Luma PEP level with the sync pulses being the strongest. Carrier Burst tracking will happen during the sync pulses with a 0° phase angle, the same way the ColorBurst does. The 'Q' channel can contain control data for full motion field line interpolation de-interlacing, backing (re)store during(after) motion, static multiple frame storage averaging for noise reduction, various other data, and digital sound

Combinations

Sub-Nyquist Modes: 1272×672, 1168×720, 1344×768, 1440×816

Resolution, Horizontal (kHz), Chroma (mHz), Sound (mHz), Channel Space (mHz) ; C = Chroma ; F = Frame Rate %

768×432, 11.4913, , 4.7968708, 6 ; 768×480, 12.6092, , 4.7914871, 6 ; 1272×672, 17.8289, , 4.7959836, 6 ; C: 3.5747015 ; F: ±0.1175%
 848×480, 12.6235, , 5.7941967, 7 ; 848×528, 14.0639, , 5.7943367, 7 ; 1344×768, 20.4008, , 5.7938194, 7 ; C: 4.437168 ; F: ±0.00379%
 928×528, 14.0639, , 6.7511947, 8 ; 920×576, 15.2218, , 6.7584995, 8 ; C: 4.437168 ; F: -0.00054%, +0.0384%
 848×480, 12.6213, , 5.7931936, 7 ; 848×528, 14.0615, , 5.7933336, 7 ; 1344×768, 20.3972, , 5.7928164, 7 ; C: 4.4363999 ; F: ±0.0211%
 928×528, 14.0615, , 6.7495149, 8 ; 920×576, 15.2192, , 6.7573295, 8 ; C: 4.4363999 ; F: ±0.0211%
 1168×720, 18.960, 3.57396, 4.79688, 6 ; 1440×816, 21.552, 5.097048, 6.745776, 8

Studio Quality 4:3 Aspect 480i72 / 480p24 **CRP™**@3.58MHz NTSC-F72/3 6mHz Channel

For the vertical scan a 3:1 interlace is used at a field rate of 72 Hz to produce the Film standard 24 frames per second. For the horizontal no sub-sampling will be used and the full refresh rate will also be at 24 frames per second, $41\frac{2}{3}$ ms. Using a 3:1 interlace at 72 Hz with $175\frac{1}{3}$ lines allows the use of a lower horizontal scan rate providing increased definition of the Luma channel and the normal aspect ratio of 4:3 is used. **Chroma** Rotary Phase™ will be used instead of NTSC **Chroma** since its dot matrix pattern works better with the 3:1 interlace while still offering a two frame repeat pattern and the 3.58MHz **Chroma** sub-carrier frequency will be used. The sound is at 4.5MHz having 3 separate channels of audio, **L+R**, **L-R**, & **S**urround.

General:

Aspect Ratio	4:3 = $1\frac{1}{3}$
Total Picture Pixels (Digital)	640×480 ; 307200 Pixels
Kell Factor (Analog Resolution)	452×340 ; 153600 Pixels
Broadcast	434×340 ; 147362 Pixels



Vertical:

Frames Per Second	24.0043 Hz, +0.018%	(24)
Total Lines Per Frame	526 (2 Frame CRP™ Dot Repeat)	
Fields Per Second	72.0129 Hz	(72)
Total Lines Per Field	$175\frac{1}{3}$	
Picture Lines	160	
Lines Per Blank	$15\frac{1}{3}$	
Blank	1.214 ms	
Sync	238 μs ; 3 Lines	

Horizontal:

Resolution Good:	434	Max@-8dB:	536
Lines Per Second	12.626261 kHz		(12624)
Period (HP)	79.2 μs		
Picture Period	68.305 μs		
Total Picture Pixels	$464 \approx \phi \times \lambda_{BW} \times (HP - HB)$; $(434+30) \approx 6\frac{1}{2}\%$ OverScan		
Total Clock Pixels Per Line	567		
Blank (HB)	10.895 μs		(78)
Front Porch	1.397 μs		(10)
Sync	4.61 μs		(33)
Back Porch	4.889 μs		(35)

Luma & Chroma:

Luma (λ) Bandwidth @-3dB	$4\frac{1}{3}$ MHz ; Vestigial $1\frac{1}{4}$ MHz, Corner $\frac{3}{4}$ MHz
Chroma:	Sub-Sampling $2\frac{2}{3}:1:\frac{2}{3}$
Sub-Carrier	3.579545 MHz [NTSC] (3.578904)
$\frac{1}{2}$ H Odd Harmonic	567 ($283\frac{1}{2}$)
I Bandwidth	$1\frac{1}{2}$ MHz (USB $+\frac{3}{5}$ MHz & LSB $-1\frac{1}{2}$ MHz)
Q Bandwidth	$\frac{3}{5}$ MHz (USB $+\frac{3}{5}$ MHz & LSB $-\frac{3}{5}$ MHz)
Color Burst Duration	2.794 μs ; 10 cycles $2 \times (3+10+4\frac{1}{2})=35$
Baseband Guard	2 MHz

Stereo Sound:

	(4.494144)
FM SubCarrier	4.494949 MHz ± 25 kHz, ± 50 kHz, ± 73 kHz
H Harmonic	356 L+R , add L-R , add SAP
L & R Frequency Response	L+R 50Hz-15kHz, L-R 125Hz-15kHz
Equalization	75μs Pre-Emphasis
Harmonic Peak Shifting	65μs & 650μs Phase Shift Networks (Optional)
L-R Sub-Carrier 3×H	37.878784 (37872)
Modulation	Double Sideband Suppressed Carrier AM
Encoding	dbx

While the above specifications are for an NTSC version using 24Fps/72fps, 3:1 interlace, and Chroma Rotary Phase™, the schematic below is for a 720x480 resolution (3:2 aspect ratio) and optimized for increased Luma bandwidth. It is also specified on page 20 & 45 although chroma and horizontal frequencies vary somewhat from drawing.

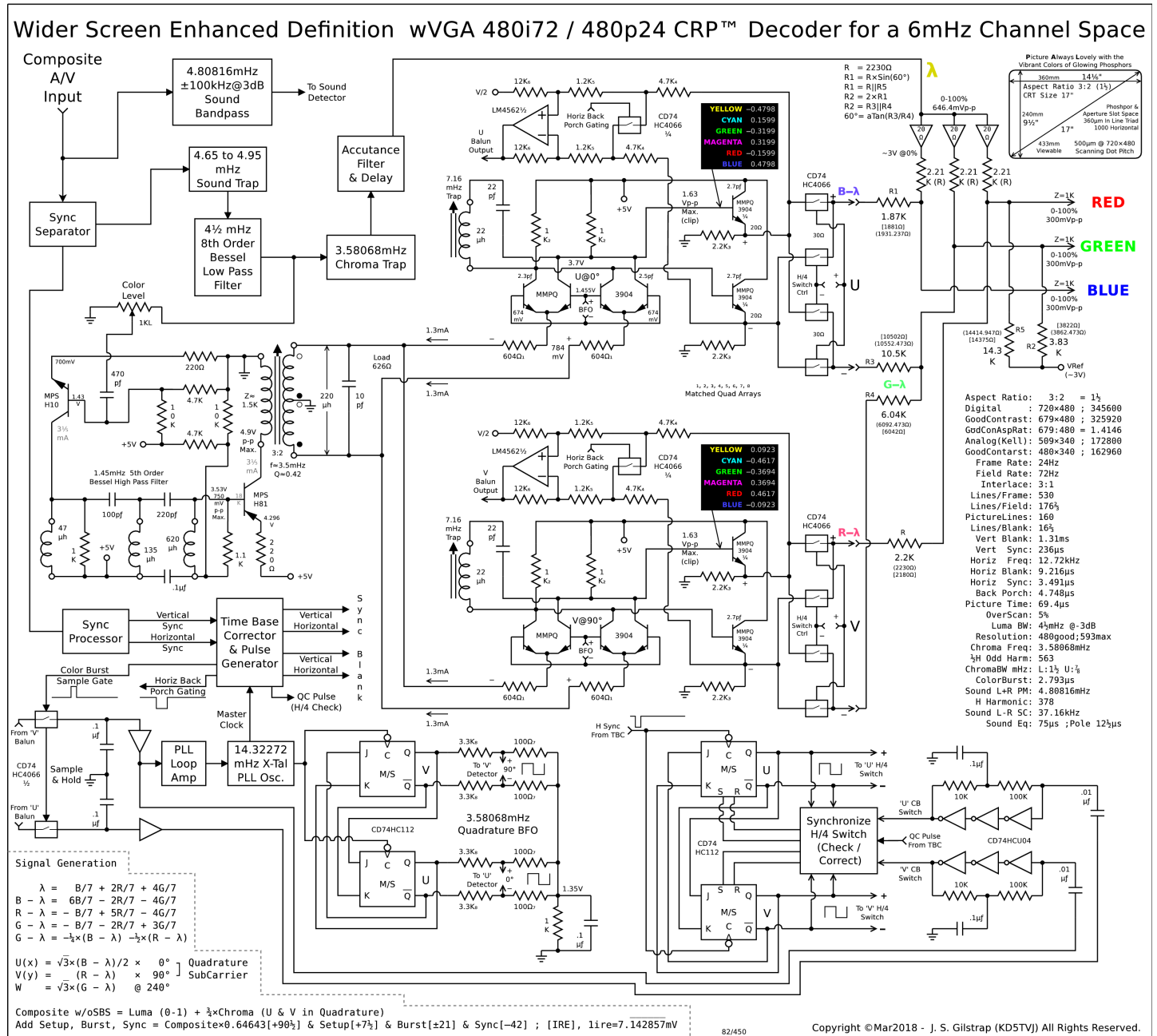

2 frame 526 line Chroma Rotary Phase™ dot repeat pattern with sync alignment. This is for U & V axes rotating 90° every line in opposite directions which also causes I & Q axes to flip 180° every other line but their flips are offset by one line from each other. The schematic above flips U & V axes 180° alternately every other line thus causing I & Q axes to rotate 90° on every line.



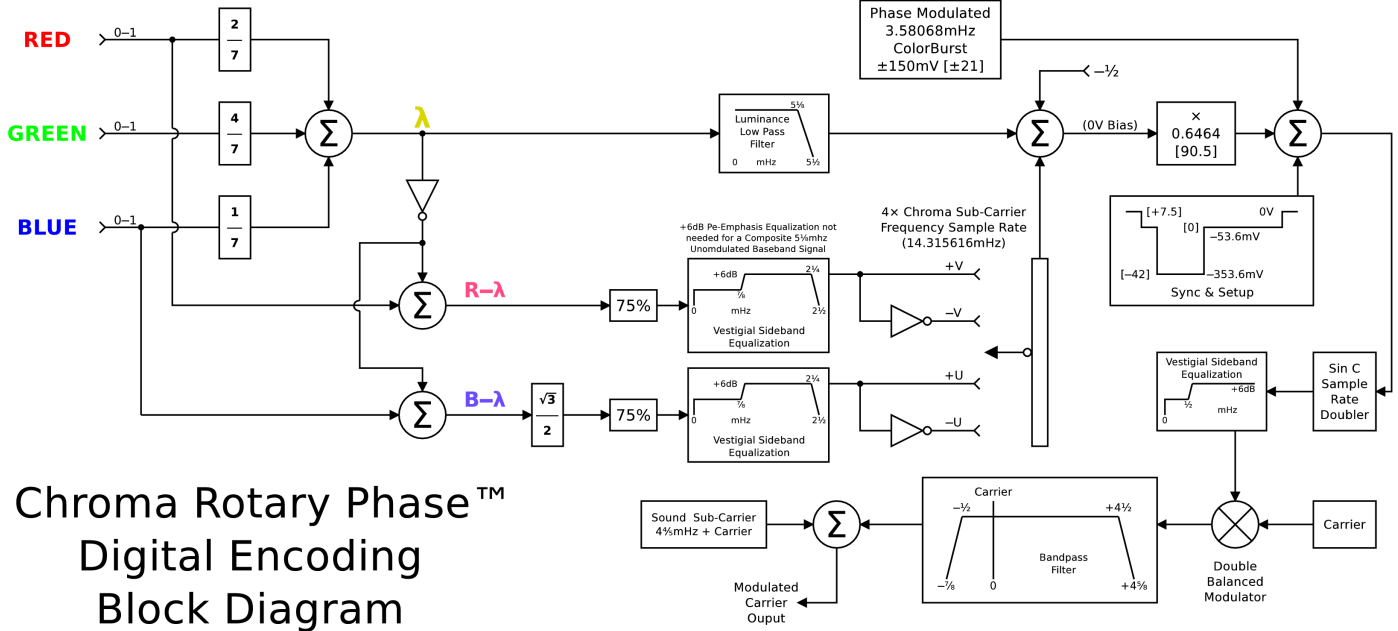

Chroma Rotary Phase™ Digital Encoding Block Diagram

Chroma Sampling

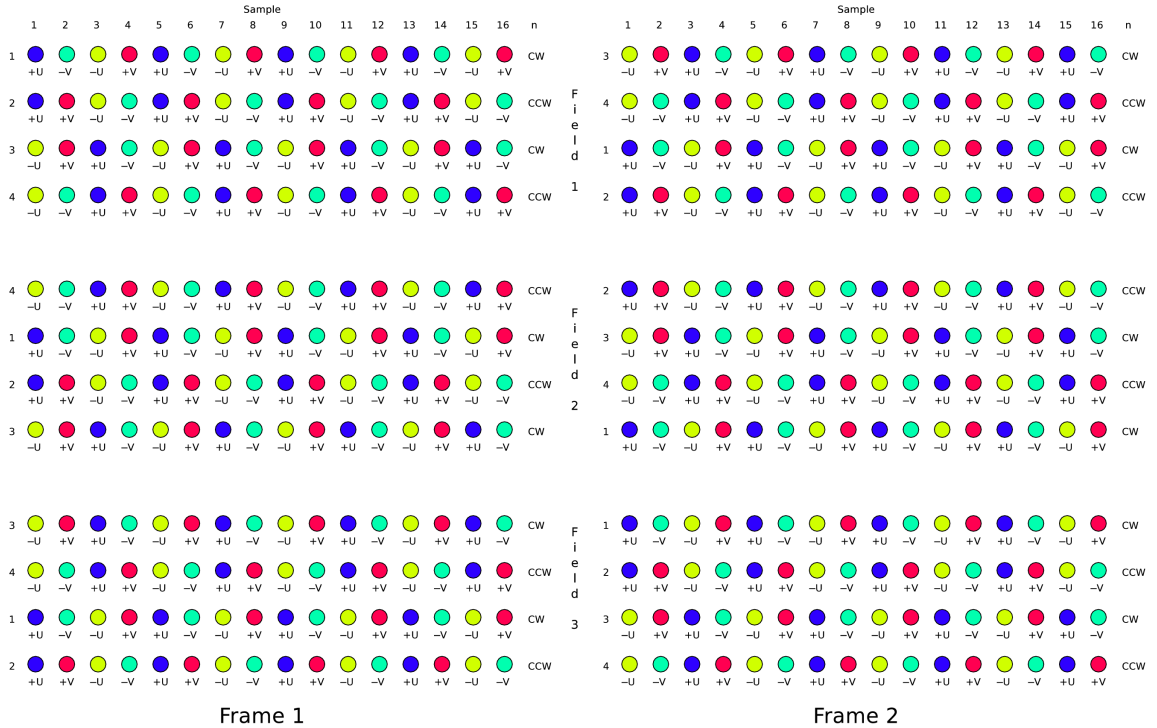

Copyright © Mar 2018
J. S. Gilstrap - KD5TVJ
All Rights Reserved.

Sin C or Cubic sample doubling may not provide high enough accuracy to faithfully create the Chroma sub-carrier signal. For better accuracy use the higher sample rate of 28.64mHz which is 8 times the Chroma in 45° steps instead of 4 times at 14.32mHz in 90° steps for a 3.58mHz Chroma sub-carrier frequency. This higher sample rate is required if a Sub-Nyquist sampling scheme is used since 8 Luma samples are generated per Chroma cycle.

X × Y	Diagonal		X × Y	Diagonal			
Cm × Cm	Cm	In	Cm × Cm	Cm	In		
27 × 18	32½	12¼	✓13"	45 × 30	54	21¼	
30 × 20	36	14⅓		48⅓ × 32⅓	58⅓	23	✓23"
33 × 22	39⅔	15⅔		51 × 34	61⅓	24⅓	
36 × 24	43¼	17	✓17"	54 × 36	64⅞	25½	✓25+"
39 × 26	46⅞	18½		57 × 38	68½	27	✓27"
42 × 28	50½	19⅞	✓20"	60 × 40	72⅓	28⅔	

Chroma Rotary Phase™ 8X Sampling

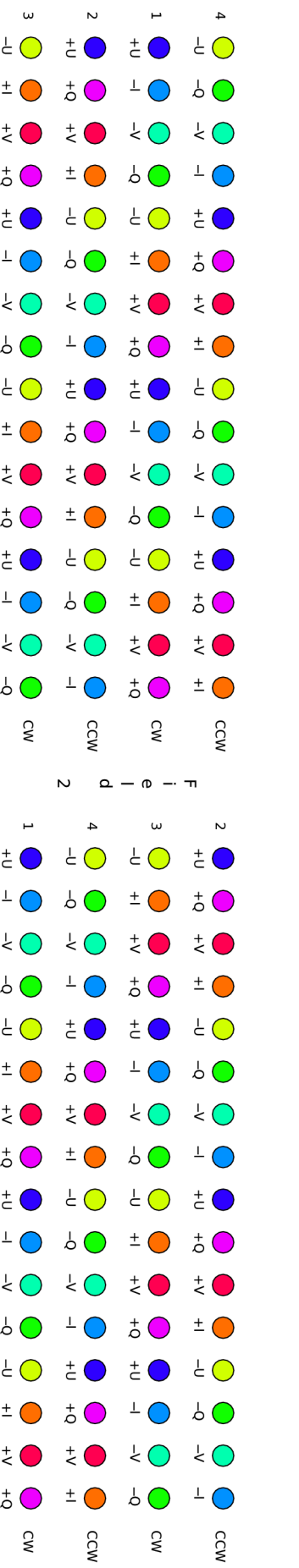
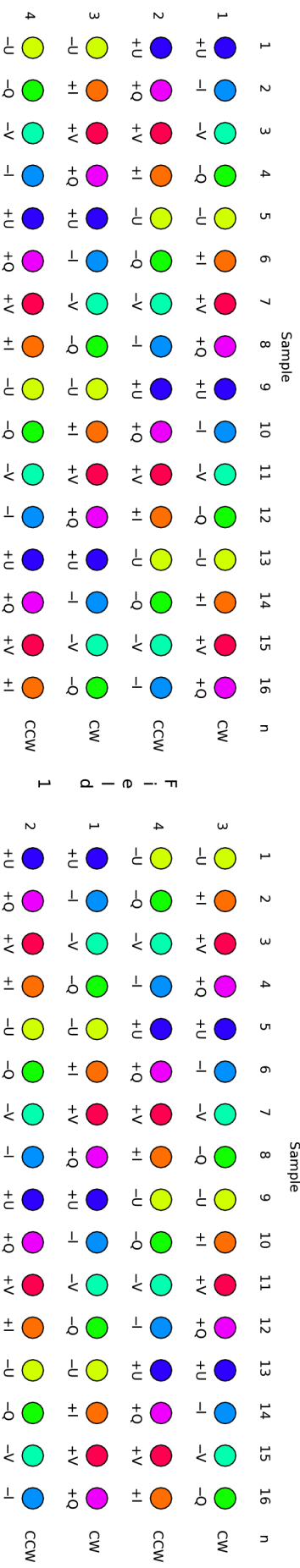

Frame 1

Frame 2

Wider Screen High Definition wXGA 816i72 / 816p24 **CRP™** for an 7mHz Channel Space

For the vertical scan a 3:1 interlace is used at a field rate of 72 Hz with $299\frac{1}{3}$ lines to produce the Film standard 24 frames per second, $41\frac{2}{3}$ ms. For the horizontal scan a 4:1 pixel interlaced sub-nyquist sampling is used to almost triple the Luma resolution, à la MUSE Hi-Vision. Below is a rough layout of the specification. It takes $\frac{1}{6}$ of a second (166ms), 4 full frames (12 fields) to receive the full high definition image. A frame buffer is used to store the 4 frames to assemble a full resolution still picture. For motion the 72 Hz field rate will provide a reduced resolution de-interlaced image with motion blur every $13.\bar{8}$ ms. **Chroma** Rotary Phase™ with a 4.43 mHz sub-carrier frequency will be used since its dot matrix pattern works better with the 3:1 interlace while still offering a two frame repeat pattern. The sound is on a 5.8 mHz sub-carrier that can handle 3 separate channels of audio, L+R, L-R, and SAP or Surround.

General:

		Stretch to:
Aspect Ratio	26:17 ≈ 1.5294	8:5 = $1\frac{3}{5}$
Total Picture Pixels (Digital)	1248×816 ; 1018368 Pixels	1305×816 ; 1064880
Kell Factor (Analog Resolution)	882×577 ; 509184 Pixels	923×577 ; 532440
Sub-Nyquist(x) & Interlace(y)	312×272 (4:1 & 3:1)	

Vertical:

Frames Per Second	24 Hz (24.0446, +0.1859%)	
Total Lines Per Frame	898 (2 Frame CRP™ Dot Repeat)	[24.0254, +0.1057%]
Fields Per Second	72 Hz (72.1213)	[72.0761]
Total Lines Per Field	$299\frac{1}{3}$ (72.1338)	
Picture Lines	272	
Lines Per Blank	$27\frac{1}{3}$	
Blank	1.268 ms	
Sync	186 μs ; 4 Line	

Horizontal:

	Resolution Good:313 Max@-8dB:387	
Freq, Period (Hp), Clock Pixel/Lines	21.552 kHz, 46.3994 μs, 411	(21.588321]
Picture BW Pixels	$330 \approx \phi \times \lambda_{BW} \times (HP - HB)$; (312+18)≈5½%	(21.592058]
Total Picture Clock ; Period	330 ; 37.255 μs	OverScan [21.574787]
Blank (Hb)	81 ; 9.144 μs	
Front Porch	8 ; 0.903 μs	
Sync	31 ; 3.500 μs	
Back Porch	42 ; 4.742 μs	

Luma & Chroma:

Luma (λ) Bandwidth @-3dB	5½ mHz ; Vestigial $\frac{7}{8}$ mHz, Corner $\frac{1}{2}$ mHz	
Chroma:	Sub-Sampling $5\frac{5}{8}:1:\frac{1}{3}$	
Sub-Carrier	4.428936 mHz (4.4363999) [PAL 4.43361875]	
½H Odd Harmonic	411 (205½)	(4.437168)
Saturation Bandwidth	$2\frac{3}{4}$ mHz (USB + $\frac{7}{8}$ mHz & LSB - $1\frac{3}{4}$ mHz)	
Hue Bandwidth	$\frac{7}{8}$ mHz (USB + $\frac{7}{8}$ mHz & LSB - $\frac{7}{8}$ mHz)	
Color Burst Duration	2.68 μs ; 12 cycles	2×(4+12+6)=44
Baseband Guard	$1\frac{1}{2}$ mHz	

Stereo Sound:

PM SubCarrier ±157½° ± $\frac{7}{8}\pi$ ±2¾R	5.797488 mHz (5.8072583) [5.80361773]	
H Harmonic	269	(5.8082637)
L & R Frequency Response	L+R 50Hz-15kHz, L-R 125Hz-15kHz	
Equalization	75μs Pre-Emphasis, Shelf at 12.73kHz (12½μs)	
Harmonic Peak Shifting	65μs & 650μs Phase Shift Networks (Optional)	
L-R Sub-Carrier 2×H	43.104 kHz (43.176641370) [43.149574]	
Modulation	Unlimited Armstrong PM ±74°, Peak Q:I=3½	
	Companer Controlled 'I' Channel	(43.18411676)

Video Harmonics: Coarse Mesh Cluster & Fine Mesh Interleaving

In PAL with a 2 : 1 interlace when the Chroma 'U' channel is at the $\frac{1}{2}$ offset as it is in NTSC it does not interfere with the Luma but when the 'V' channel in the same spot is switched at the H/2 rate 'V' is sub-modulated creating a $\pm H/2$ DSB-SC signal. With the sub-modulating carrier of H/2 being in the kHz range and the modulated Chroma sub-carrier bandwidth in the mHz range the upper and lower sidebands of the H/2 sub-modulation almost completely overlap. With the combining of the sidebands along with the 'U' channel if the harmonics overlap they will either reinforce and increase in strength or nullify and create Fukinuki holes. Having the Chroma sub-carrier lie in the $\frac{1}{2}$ center offset between the Luma clusters the 'V' sub-sidebands are displaced at $\pm H/2$ causing the center of the upper and lower sub-sidebands to fall directly on top of the Luma clusters creating direct interference and making them impossible to separate. To eliminate this the Chroma sub-carrier is placed at the $\frac{3}{4}$ offset instead of the $\frac{1}{2}$ offset and the $\pm H/2$ 'V' sub-sideband centers fall on the $\frac{1}{4}$ offset or for PAL -M in Brasil the sub-carrier is at the $\frac{1}{4}$ offset and the $\pm H/2$ 'V' sideband centers fall on the $\frac{3}{4}$ offset. The $\frac{1}{4} \parallel \frac{3}{4}$ offset of the 'U' channel sub-carrier does not cause interference with the Luma either.

While this eliminates interference on both the coarse and fine mesh spectrum between the Luma, 'U' & 'V' channels it creates another problem, objectionable on screen standing Chroma dot patterns thus fracturing the on screen Chroma dot pattern of NTSC which is designed to be inverted on every other frame averaging out the Luma brightness. To eliminate this on screen pattern problem the Chroma sub-carrier frequency is shifted by the number of cycles in a frame thus causing the on screen dot pattern to invert rapidly enough for every spot on screen making the dot pattern invert more like NTSC. Combining this with the 4 unique states of the 'V' switch, odd number of lines per frame and 2 : 1 interlacing it takes 8 fields or 4 frames before on screen Chroma phasing repeats. Shifting the fine mesh spectra of the Chroma by 1 frame rate does not cause interference to the Luma as the new slots for the Chroma harmonics are also empty, not being occupied by Luma harmonics, but it does make every Luma/Chroma line combination unique for the 4 frame repeat pattern. While this solves the Luma/Chroma interference issues and the on screen dot pattern problems, inverting the Chroma sub-carrier on screen dot pattern by shifting the Chroma sub-carrier frequency by 1 frame rate causes the sub-carrier to creep 1 cycle per frame. This creates additional issues with advanced digital decoding and processing, having way too many more than 4 unique Chroma scan line patterns makes the math all that much more complicated.

While PAL solved the drifting hue issues of NTSC each change created another issue for which another solution was necessary. The 'V' switch feature/bug caused Luma interference which was solved by placing the sub-carrier on a $\frac{1}{4} \parallel \frac{3}{4}$ offset instead of the $\frac{1}{2}$ offset. The offset feature/bug created the standing on screen dot patterns which was solved by increasing the sub-carrier frequency by 1 frame rate. In the end the Luma/Chroma sub-carrier relationship of PAL is inherently more complex than NTSC and when digital processing with 3 line 3-D comb filters and frame storage came along NTSC with its Luma/Chroma simplicity naturally lent itself to complete Luma/Chroma separation for static images via temporal frame storage and for motion simple 3 line comb filters provided good enough separation. Having enough Luma/Chroma separation the drifting hue issues mostly disappear as it does in S-Video sources since varying Luma levels was the main cause especially with the old tube Chroma decoders. The newer transistor or IC decoders have much better DC tracking in the colorburst loop filter along with some correction signals transmitted during the vertical blank to help minimize hue errors. Multipath signal degradation of NTSC can still cause significant hue errors whereas PAL mostly corrects for this with some loss in color saturation and is one of the the saving graces that PAL still has over NTSC now. With PAL digital processing is less glamorous but still beneficial. More complex algorithms and increased compute power are needed to achieve comparable results although the level achieved with PAL is still not as good as it is with NTSC.

This detour into PAL is a good description with what happens when a Chroma sub-carrier is sub-modulated at a fractional rate of the horizontal frequency, the issues it creates and the solutions used to address them. For a more detailed description many articles about PAL since its inception in the early 1960s are probably available. This description is here since Chroma Rotary Phase™ also uses Chroma sub-carrier sub-modulation but is a more elegant approach than PAL. As with PAL it automatically corrects for hue errors but also eliminates instead of creating Luma/Chroma fine mesh spectral interference when a normal NTSC Chroma modulation is used with a 3 : 1 interlace. A cleaner implementation avoiding the pitfalls that PAL creates and with the 3 : 1 interlace Hanover lines are created instead of bars. A balanced solution with an on screen Chroma dot pattern that is more uniform with a natural 2 frame repeat rate. On a per frame basis if the hue falls directly on the U or V axis the Chroma dot pattern is identical to NTSC with line pairs of vertically aligned dots which create a diagonal pattern. Only when the hue falls directly in the middle of the U & V axes is a pure diagonal line of dots created. This predictable dot pattern makes it as simple to process digitally as NTSC.

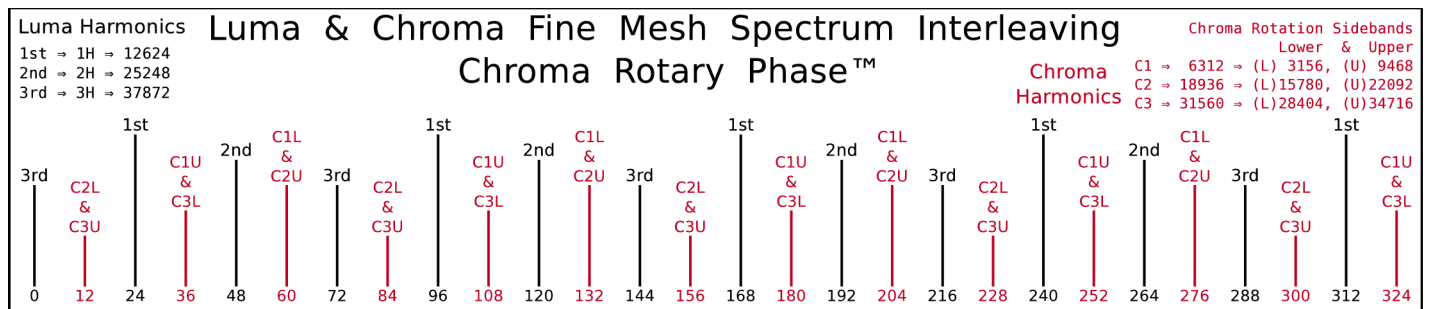

In the image above using a 3 : 1 interlace the normalized spectrum distribution of Luma with Chroma Rotary Phase™ is shown at the fine mesh level. The 3 : 1 interlace with a 72Hz field rate ending with $\frac{1}{3}$ line causes the Luma and Chroma harmonics to be placed at 24Hz intervals which is also the frame rate. As with NTSC Chroma the sub-carrier is placed at an odd multiple of $\frac{1}{2}$ horizontal rate so at the coarse mesh level the Chroma clusters will lie in the center between the Luma Clusters. When a conventional NTSC Chroma modulation method is used with a 3 : 1 interlace the fine mesh Luma and Chroma adjacent cluster harmonics do not interfere with each other but interference does occur $1\frac{1}{2}$ clusters away from each other and then every 3rd cluster after that. Chroma Rotary Phase™ offsets this causing all Chroma harmonics to fall evenly between all Luma harmonics at the fine mesh level in a Luma/Chroma 12Hz interval throughout the combined Luma/Chroma spectrum. This is because both Chroma channels are sub-modulated at the H/4 rate creating a $\pm H/4$ DSB-SC signal in which the sidebands are centered on the $\frac{1}{4}$ & $\frac{3}{4}$ offsets. Having the Luma and Chroma fine mesh harmonics spaced at 24Hz intervals for cluster triads and that H/4 is not evenly divisible by 24 but is divisible by 12 with a quotient that is odd means that all Chroma harmonics are shifted by ± 12 Hz off center thus moving them away from interference with the Luma and placing them exactly centered in between them. The H/4 modulation also creates overlapping Chroma harmonics from the upper and lower sidebands in a triad configuration of: C1U & C3L, C1L & C2U, and C3U & C2L. This is a repeating 3 cluster pattern even when shifting over 1 cluster at a time. A Fourier spectral analysis has not been done but for the overlapping harmonics it can be assumed that some may be constructive and increase in strength and others may be completely destructive and create Fukinuki holes. The most desirable outcome would be for Chroma harmonics which are from adjacent Chroma clusters and are centered within a Chroma cluster are constructive and those that are centered within the Luma clusters are destructive and are the ones creating the Fukinuki holes. For the Luma the reverse is not true as it is not sub-modulated. For both Luma and Chroma the harmonics for each cluster are spaced 72Hz apart and for a cluster triad there is a 24Hz offset between the 3 so the combined triad of harmonics creates the 24Hz interval. As with a 2 : 1 interlace the energy in between the Luma clusters is minimal and is where and why the Chroma clusters were placed there originally. The void of strong harmonics in between the Luma clusters for a 3 : 1 interlace is probably very similar to a 2 : 1 interlace. Even if the voids are not as defined as a 2 : 1 interlace the Luma/Chroma fine mesh harmonic separation at the 12Hz interval is as evenly spaced as NTSC's 15Hz interval which is $\text{FrameRate}/2$ for both.

To make all this work seamlessly it is the combination of Chroma Rotary Phase™ with a 3 : 1 interlace using an even number of scan lines per frame to fit together like puzzle and work synergistically. When the number of lines per frame is evenly divisible by 2 and the quotient is odd then the 4 line Chroma rotation pattern is advanced by 1 line per ' $\frac{1}{2}$ frame' and over 4 ' $\frac{1}{2}$ frames' (2 frames) the Chroma rotation pattern evenly repeats. When the number of lines per frame is divided by 3 the lines per field must end with $\frac{1}{3}$ line to create the 3 : 1 interlace. It is also possible to end with $\frac{2}{3}$ line and have a 3 : 1 interlace but this may be less optimal as it may take a greater staggering of the vertical sync pulse to create the uniform on screen Chroma dot pattern as illustrated earlier when $\frac{1}{3}$ line is used. However if it is determined that a $\frac{2}{3}$ line offset has distinct advantages and does not introduce any un-resolvable conflicts then it should be used instead, e.g. scan lines move down the screen but for sequential fields the line groups move up and this may help counteract any visual movement whereas $\frac{1}{3}$ line offset causes field lines to sequentially move down the screen accentuating visually the top to bottom scan pattern. This movement is not an issue with a 2 : 1 interlace as it is an alternate blinking motionless pattern although with the 3 : 1 interlace the field rate is faster than NTSCi60 at 72Hz so this may help some. For CRTs greater phosphor persistence could be balanced to eliminate visible scan line movement without causing motion blurring. This becomes a non-issue if the image is de-interlaced for CRT progressive scan or is displayed on a flat panel which will be de-interlaced anyway.

Per Field Luma Separation 3 Line Processing For Non-Static Full Motion Image Areas

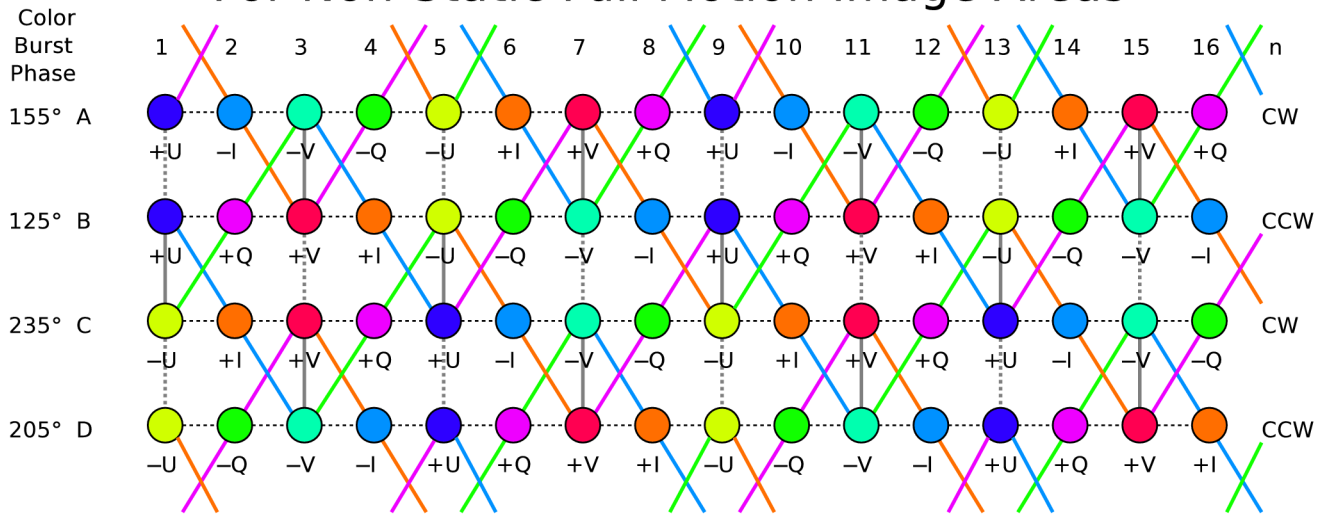

For Luma samples that fall on I or Q Chroma Sample points there are 2 Luma samples from U & V sample points from adjacent lines on the diagonal that when added together will form the complimentary color to cancel out the Chroma on each Luma sample. The mapping is shown via the complimentary color lines connected to an I or Q sample and the associated U & V samples. The ratio is $(\sqrt{2}:2:\sqrt{2})/(1+\sqrt{2})/2$.

For Luma samples that fall on U or V sample points U or V points directly above or below on adjacent lines are added or subtracted to cancel out Chroma on each Luma sample point. The mapping is shown via gray lines. Solid lines are additive and dotted lines are subtractive. The ratio is $(\pm 1:2:\pm 1)/2$.

Since Luma sample recovery on I or Q sample points is all additive it provides noise reduction but Luma sample recovery on U or V sample points have some S/N loss since adjacent lines are subtracted nullifying Luma but additive for the complimentary color that cancels out Chroma on the current line leaving only the Luma from the current line but also the noise from the adjacent lines.

To average out this noise variation between the I & Q and U & V sample points the recovered Luma on a line can be a running average of 3 points in a $(1:2:1)/4$ ratio or 5 points in a $(1:2:4:2:1)/10$ ratio. This averaging has minimal effect on sharpness since the sample rate is $\sim 3\frac{3}{4}$ times the image resolution.

To eliminate Luma and obtain Chroma it can be as simple as subtracting adjacent lines from the current line as in NTSC with the $(1:2:1)/4$ ratio. Unlike NTSC the adjacent lines do not contribute any to Chroma levels but just nullify the Luma. The Chroma on the adjacent lines are inverted to each other so when they are added together the Chroma is nullified. Inverting these 2 summed lines will produce inverted Luma which will nullify the Luma on the current line leaving only the quadrature Chroma signal to be used for Chroma decoding. However this method does not correct for hue phase errors and some lines of Chroma resolution are lost nor does it produce the best S/N ratio.

Subtracting one line, above or below from the current line will eliminate the Luma and either the U or V Chroma channel. This method will correct for hue phase errors and produce much better S/N ratio but the Chroma lines of resolution will be cut in half. Which Chroma channel that will be eliminated and which one will remain will depend on which chroma phase rotation the current line is using.

A: $a-d \Rightarrow +U$, $a-b \Rightarrow -V$; B: $b-a \Rightarrow +V$, $b-c \Rightarrow +U$; C: $c-b \Rightarrow -U$, $c-d \Rightarrow +V$; D: $d-c \Rightarrow -V$, $d-a \Rightarrow -U$.

For positive values: $a-d$ & $b-c \Rightarrow +U$; $b-a$ & $c-d \Rightarrow +V$ and for negative $d-a$ & $c-b \Rightarrow -U$; $a-b$ & $d-c \Rightarrow -V$.

Since the Chroma sub-carrier is inverted 180° from frame to frame to average out Luma brightness two frames can be added or subtracted to obtain the Luma or Chroma respectively so motion free static image areas will produce full Luma/Chroma separation without any artifacts. This will produce the highest resolution and best S/N ratio but unless adjacent line Chroma information is incorporated with the current line any hue phase errors that exist will not be canceled out but will produce Hanover lines that may be visible and viewer must rely on visual blending for the correct hue.

Wider Aspect Enhanced Definition wVGA 528i72 / 528p24 CRP™ for a 7mHz Channel Space

For the vertical scan a 3:1 interlace is used at a field rate of 72 Hz to produce the Film standard 24 frames per second. For the horizontal no sub-sampling will be used and the full refresh rate will also be at 24 frames per second, $41\frac{2}{3}$ ms. For a $\frac{2}{3}$ line offset having the 1st field arrive one line early in relation to the other two fields instead of 1 line later as for the $\frac{1}{3}$ line offset should properly align the Chroma dot pattern diagonally. Using a 3:1 interlace at 72 Hz with $192\frac{2}{3}$ lines allows the use of a slightly lower horizontal scan rate providing increased definition of the Luma channel and an aspect ratio just slightly wider than 4:3 at 3:2. Chroma Rotary Phase™ will be used instead of NTSC Chroma since its dot matrix pattern works better with the 3:1 interlace while still offering a two frame repeat pattern. With the increased Luma bandwidth this allows a higher Chroma sub-carrier frequency of 4.43mHz to be used. The sound is on a 5.8mHz sub-carrier that can handle 3 separate channels of audio, L+R, L-R, and SAP or Surround.

General:

	3:2 = $1\frac{1}{2}$	Good Contrast
Aspect Ratio		47:33 = 1.42
Total Picture Pixels (Digital)	792×528 ; 418176 Pixels	752×528 ; 397056
Kell Factor (Analog Resolution)	560×373 ; 209088 Pixels	532×373 ; 198528

Vertical:

	(24.0096 +0.04%)
Frames Per Second	24 Hz [24.0082 +0.034%]
Total Lines Per Frame	578 (2 Frame CRP™ Dot Repeat)
Fields Per Second	72 Hz [72.0246] (72.0288)
Total Lines Per Field	$192\frac{2}{3}$
Picture Lines	176
Lines Per Blank	$16\frac{2}{3}$
Blank	1.201 ms
Sync	192 μ s ; $2\frac{2}{3}$ Lines



Horizontal:

	Resolution Good:532 Max@-8dB:658
Lines Per Second	13.872 kHz [13.876741] (13.877558)
Period (HP)	72.087 μ s (639)
Total Picture Period	62.95 μ s (558)
Total Picture Pixels	$560 \approx \phi \times \lambda_{BW} \times (HP - HB)$; (532+28) \approx 5% Over Scan
Viewable Picture	532 ; 59.8 μ s
Blank (HB)	9.138 μ s (81)
Front Porch	0.903 μ s (8)
Sync	3.497 μ s (31)
Back Porch	4.738 μ s (42)

Luma & Chroma:

Luma (λ) Bandwidth @-3dB	5 $\frac{1}{2}$ mHz ; Vestigial $\frac{7}{8}$ mHz, Corner $\frac{1}{2}$ mHz
Chroma:	Sub-Sampling 4:2: $\frac{5}{8}$
Sub-Carrier	4.432104 mHz [PAL 4.43361875]
$\frac{1}{2}$ H Odd Harmonic	639 (319 $\frac{1}{2}$) (4.433879664)
Saturation Bandwidth	2 $\frac{3}{4}$ mHz (USB + $\frac{7}{8}$ mHz & LSB -2 $\frac{3}{4}$ mHz)
Hue Bandwidth	$\frac{7}{8}$ mHz (USB + $\frac{7}{8}$ mHz & LSB - $\frac{7}{8}$ mHz)
Color Burst Duration	2.708 μ s ; 12 cycles $2 \times (3\frac{1}{2} + 12 + 5\frac{1}{2}) = 42$
Baseband Guard	1 mHz

Stereo Sound:

PM SubCarrier $\pm 157\frac{1}{2}^\circ \pm \frac{7}{8}\pi \pm 2\frac{3}{4}R$	5.798496 mHz [5.80047774]
H Harmonic	418 (5.80081909)
L & R Frequency Response	L+R 50Hz-15kHz, L-R 125Hz-15kHz
Equalization	75 μ s Pre-Emphasis, Shelf at 12.73kHz (12 $\frac{1}{2}$ μ s)
Harmonic Peak Shifting	65 μ s & 650 μ s Phase Shift Networks (Optional)
L-R Sub-Carrier 3×H	41.616 kHz [41.630223] (41.632673)
Modulation	Unlimited Armstrong PM $\pm 74^\circ$, Peak Q:I=3 $\frac{1}{2}$ Compander Controlled 'I' Channel

Wide Screen High Definition WXGA 768i72 / 768p24 CRP™ for an 7mHz Channel Space

For the vertical scan a 3:1 interlace is used at a field rate of 72 Hz with 280²/₃ lines to produce the Film standard 24 frames per second, 41²/₃ms. For a ²/₃ line offset having the 1st field arrive one line early in relation to the other two fields instead of 1 line later as for the ¹/₃ line offset should properly align the Chroma dot pattern diagonally. For the horizontal scan a 4:1 pixel interlaced sub-nyquist sampling is used to almost triple the Luma resolution, à la MUSE Hi-Vision. Below is a rough layout of the specification. It takes ¹/₆ of a second (166ms), 4 full frames (12 fields) to receive the full high definition image. A frame buffer is used to store the 4 frames to assemble a full resolution still picture. For motion the 72 Hz field rate will provide a reduced resolution de-interlaced image with motion blur every 13.8 ms. Chroma Rotary Phase™ with a 4.43 mHz sub-carrier frequency will be used since its dot matrix pattern works better with the 3:1 interlace while still offering a two frame repeat pattern. The sound is on a 5.8 mHz sub-carrier that can handle 3 separate channels of audio, L+R, L-R, and SAP or Surround.

General:

Aspect Ratio	16:9 = 1.7708 ³	Stretch to:	16:9 = 1.7786
Total Picture Pixels (Digital)	1360×768 ; 1044480 Pixels		1366:768 ; 1049088
Kell Factor (Analog Resolution)	962×543 ; 522240 Pixels		965:543 ; 524544
Sub-Nyquist(x) & Interlace(y)	340×256 (4:1 & 3:1)		

Vertical:

Frames Per Second	24 Hz [23.9904, -0.0459%]	(23.9904 -0.04%)
Total Lines Per Frame	842 (2 Frame CRP™ Dot Repeat)	
Fields Per Second	72 Hz [71.9669] (71.9712)	
Total Lines Per Field	280 ² / ₃	
Picture Lines	256	
Lines Per Blank	24 ² / ₃	
Blank	1.22 ms	
Sync	198 μs ; 4 Line	(20.19990726)

Horizontal:

Resolution Good:341 Max@-8dB:421	
Freq, Period (Hp), Clock Pixel/Lines	20.208 kHz, 49.485 μs, 439 [20.198719]
Picture BW Pixels	358 ≈ φ × λBW × (Hp-Hv) ; (340+18) ≈ 5%
Total Picture Clock ; Period	358 ; 40.355 μs OverScan
Blank (Hv)	81 ; 9.131 μs
Front Porch	8 ; 0.902 μs
Sync	31 ; 3.494 μs
Back Porch	42 ; 4.734 μs

Luma & Chroma:

Luma (λ) Bandwidth @-3dB	5 ¹ / ₂ mHz ; Vestigial ⁷ / ₈ mHz, Corner ¹ / ₂ mHz
Chroma:	Sub-Sampling 5 ² / ₃ :1: ¹ / ₃
Sub-Carrier	4.435656 mHz [PAL 4.43361875]
¹ / ₂ H Odd Harmonic	439 (219 ¹ / ₂) (4.433879664)
Saturation Bandwidth	2 ³ / ₄ mHz (USB + ⁷ / ₈ mHz & LSB -2 ³ / ₄ mHz)
Hue Bandwidth	⁷ / ₈ mHz (USB + ⁷ / ₈ mHz & LSB - ⁷ / ₈ mHz)
Color Burst Duration	2.705 μs ; 12 cycles 2×(3 ¹ / ₂ +12+5 ¹ / ₂)=42
Baseband Guard	1 mHz

Stereo Sound:

PM SubCarrier ±157 ¹ / ₂ ° ± ⁷ / ₈ π ±2 ³ / ₄ R	5.799696 mHz [5.79703226]
H Harmonic	287 (5.797373385)
L & R Frequency Response	L+R 50Hz-15kHz, L-R 125Hz-15kHz
Equalization	75μs Pre-Emphasis, Shelf at 12.73kHz (12 ¹ / ₂ μs)
Harmonic Peak Shifting	65μs & 650μs Phase Shift Networks (Optional)
L-R Sub-Carrier 2×H	40.416 kHz [40.397437] (40.39981453)
Modulation	Unlimited Armstrong PM ±74°, Peak Q:I=3 ¹ / ₂ Compander Controlled 'I' Channel

Wider Screen High Definition WXGA 720i72 / 720p24 **CRP™** for a 6mHz Channel Space

For the vertical scan a 3:1 interlace is used at a field rate of 72 Hz with $260\frac{2}{3}$ lines to produce the Film standard 24 frames per second. For a $\frac{2}{3}$ line offset having the 1st field arrive one line early in relation to the other two fields instead of 1 line later as for the $\frac{1}{3}$ line offset should properly align the **Chroma** dot pattern diagonally. For the horizontal scan a 4:1 pixel interlaced sub-nyquist sampling is used to almost triple the **Luma** resolution, à la MUSE Hi-Vision. Below is a rough layout of the specification. It takes $\frac{1}{6}$ of a second (166ms), 4 full frames (12 fields) to receive the full high definition image. A frame buffer is used to store the 4 frames to assemble a full resolution still picture. For motion the 72 Hz field rate will provide a reduced resolution de-interlaced image with motion blur every $13.\bar{8}$ ms. **Chroma** Rotary Phase™ with a **3.58** mHz sub-carrier frequency will be used since its dot matrix pattern works better with the 3:1 interlace while still offering a two frame repeat pattern. The sound is on a **4.8** mHz sub-carrier that can handle **3** separate channels of audio, **L+R**, **L-R**, and **SAP** or Surround.

General:

Aspect Ratio	5:3 = $1.\bar{6}$	Stretch to:
Total Picture Pixels (Digital)	1200x720 ; 864000 Pixels	16:9 = $1.\bar{7}$ 1280x720 ; 921600
Kell Factor (Analog Resolution)	832x509 ; 432000 Pixels	905x509 ; 460800
Sub-Nyquist(x) & Interlace(y)	300x240 (4:1 & 3:1)	

Vertical:

	[24.0285, +0.1186%]
Frames Per Second	24 Hz [24.0021, +0.0086%]
Total Lines Per Frame	782 (2 Frame CRP™ Dot Repeat)
Fields Per Second	72 Hz [72.0062] [72.0854]
Total Lines Per Field	$260\frac{2}{3}$
Picture Lines	240
Lines Per Blank	$20\frac{2}{3}$
Blank	1.1 ms
Sync	195 μ s ; $3\frac{2}{3}$ Lines

Horizontal:

	Resolution Good:321 Max@-8dB:396
Freq, Period (Hp), Clock Pixel/Line	18.768 kHz, 53.282 μ s, [18.769612]
Picture BW Pixels	$315 \approx 1\frac{3}{5} \times \lambda_{BW} \times (HP-HB)$; (300+15) \approx 5% OverScan
Total Picture Clock ; Period	315 ; 44.052 μ s [18.790262]
Blank (Hb)	66 ; 9.23 μ s
Front Porch	7 ; 0.979 μ s
Sync	25 ; 3.496 μ s
Back Porch	34 ; 4.755 μ s

Luma & Chroma:

Luma (λ) Bandwidth @-3dB	$4\frac{1}{2}$ mHz ; Vestigial $\frac{7}{8}$ mHz, Corner $\frac{1}{2}$ mHz
Chroma:	Sub-Sampling $5\frac{5}{8}:1:\frac{1}{2}$
Sub-Carrier	3.575304 mHz [3.575611 PAL-M]
$\frac{1}{2}$ H Odd Harmonic	381 (190 $\frac{1}{2}$) [3.579545 NTSC]
Saturation Bandwidth	2 mHz (USB + $\frac{7}{8}$ mHz & LSB - $1\frac{1}{2}$ mHz)
Hue Bandwidth	$\frac{7}{8}$ mHz (USB + $\frac{7}{8}$ mHz & LSB - $\frac{7}{8}$ mHz)
Color Burst Duration	2.797 μ s ; 10 cycles $2 \times (2\frac{3}{4} + 10 + 4\frac{1}{4}) = 34$
Baseband Guard	$1\frac{1}{2}$ mHz

Stereo Sound:

PM SubCarrier $\pm 157\frac{1}{2}^\circ \pm \frac{7}{8}\pi \pm 2\frac{3}{4}R$	4.804608 mHz [4.8050206] [4.8103072] (4.80389)
H Harmonic	256
L & R Frequency Response	L+R 50Hz-15kHz, L-R 125Hz-15kHz
Equalization	75 μ s Pre-Emphasis, Shelf at 12.73kHz (12 $\frac{1}{2}$ μ s)
Harmonic Peak Shifting	65 μ s & 650 μ s Phase Shift Networks (Optional)
L-R Sub-Carrier 2xH	37.536 kHz [37.539223] [37.580249] (37.530393)
Modulation	Unlimited Armstrong PM $\pm 74^\circ$, Peak Q:I=3 $\frac{1}{2}$ Compander Controlled 'I' Channel

Enhanced Definition WSVGA 624i72 / 624p24 w/CRP™ for a 4mHz Channel Space

For the vertical scan a 3:1 interlace is used at a field rate of 72 Hz with $224\frac{2}{3}$ lines to produce the Film standard 24 frames per second. For a $\frac{2}{3}$ line offset having the 1st field arrive one line early in relation to the other two fields instead of 1 line later as for the $\frac{1}{3}$ line offset should properly align the Chroma dot pattern diagonally. For the horizontal scan a 4:1 pixel interlacing sub-nyquist sampling is used to almost triple the Luma resolution, à la MUSE Hi-Vision with a golden aspect ratio of ϕ , $(1+\sqrt{5})\div 2$. Below is a rough layout of the specification. It takes $\frac{1}{8}$ of a second (166ms), 4 full frames (12 fields) to receive the full high definition image. A frame buffer is used to store the 4 frames to assemble a full resolution still picture. For motion the 72 Hz field rate will provide a reduced resolution de-interlaced image with motion blur every $13.\bar{8}$ ms. Chroma Rotary Phase™ with a 2.5 mHz sub-carrier frequency will be used since its dot matrix pattern works better with the 3:1 interlace while still offering a two frame repeat pattern. The PM sound sub-carriers are on the 'Q' channel of the main carrier.



$41\frac{1}{5}$ " diagonal, (35 "x $21\frac{2}{3}$ "), $104\frac{5}{8}$ cm diagonal, (89 ×55 cm), 881µm dot pitch.
 $32\frac{1}{3}$ " diagonal, ($27\frac{1}{2}$ "x17 "), $82\frac{1}{8}$ cm diagonal, ($69\frac{7}{8}$ x $43\frac{1}{8}$ cm), 692µm dot pitch.
 $25\frac{1}{2}$ " diagonal, ($21\frac{2}{3}$ "x $13\frac{3}{8}$ "), $64\frac{2}{3}$ cm diagonal, (55 ×34 cm), 545µm dot pitch.

General:

Aspect Ratio	63:39 $\approx \phi$
Total Picture Pixels (Digital)	1008x624 ; 628992 Pixels
Kell Factor (Analog Resolution)	712x441 ; 314496 Pixels
Sub-Nyquist(x) & Interlace(y)	252x208 (4:1 & 3:1)

Vertical:

Frames Per Second	24 Hz [24.0078 +0.0323%]
Total Lines Per Frame	674 (2 Frame CRP™ Dot Repeat)
Fields Per Second	72 Hz [72.0233]
Total Lines Per Field	$224\frac{2}{3}$
Picture Lines	208
Lines Per Blank	$16\frac{2}{3}$
Blank	1.03 ms
Sync	206 µs ; $3\frac{1}{3}$ Lines

Horizontal:

	Resolution Good:255 Max@-8dB:315
Freq, Period (Hp), Clock Pixel/Line	16.176 kHz, 61.82 µs, [16181.23]
Picture BW Pixels	$264\approx \phi\times\lambda_{BW}\times(Hp-Hb)$; (252+12) $\approx 4\frac{1}{2}\%$ OverScan
Total Picture Clock ; Period	264 ; 52.817 µs
Blank (Hb)	45 ; 9.003 µs [9.0]
Front Porch	5 ; 1.000 µs [1.0]
Sync	17 ; 3.401 µs [3.4]
Back Porch	23 ; 4.602 µs [4.6]

Luma & Chroma:

Luma (λ) Bandwidth @-3dB	$3\frac{1}{8}$ mHz ; Vestigial $\frac{5}{8}$ mHz, Corner $\frac{3}{8}$ mHz
Chroma:	Sub-Sampling $5\frac{5}{8}:1:\frac{2}{3}$
Sub-Carrier	2.499192 mHz [2.5]
$\frac{1}{2}$ H Odd Harmonic	309 (154 $\frac{1}{2}$)
Saturation Bandwidth	$1\frac{1}{2}$ mHz (USB + $\frac{5}{8}$ mHz & LSB - $1\frac{1}{2}$ mHz)
Hue Bandwidth	$\frac{5}{8}$ mHz (USB + $\frac{5}{8}$ mHz & LSB - $\frac{5}{8}$ mHz)
Color Burst Duration	2.802 µs ; 7 cycles $2\times(1\frac{3}{4}+7+2\frac{3}{4})=23$
Baseband Guard	$\frac{3}{4}$ mHz

Sound: Sub-Carriers on 'Q' Channel of Main Carrier. PM Deviation: $\pm\frac{7}{8}\pi$ $\pm 2\frac{3}{4}R$ $\pm 157\frac{1}{2}^\circ$
 Sub-Carrier Frequencies: L+R: $5\frac{1}{2}\times H$ 88.968kHz [88.996764] $4\frac{1}{2}\times H$ 72.792kHz $\pm 1R$ $\pm 573^\circ$
 L-R: $17\frac{1}{2}\times H$ 283.080kHz [283.171521] (50Hz-15kHz Mono Only)
 Frequency Response 50Hz-15kHz @ -3dB (5.1 Digital;~13 QAM/COFDM Slots @7 $\frac{1}{2}$ kHz)
 Equalization 75µs Pre-Emphasis, Shelf at 12.73kHz (12 $\frac{1}{2}$ µs)
 Harmonic Peak Shifting 65µs & 650µs Phase Shift Networks (Optional)

Wider Screen Enhanced Definition **DVD 480i72 / 480p24 w/CRP™** for a **6mHz** Channel Space
 Better than **NTSC/PAL-M** Broadcast Resolution (+52%) using 1 U.S. Channel Space

For the vertical scan a 3:1 interlace is used at a field rate of 72 Hz to produce the Film standard 24 frames per second. For the horizontal no sub-sampling will be used and the full refresh rate will also be at 24 frames per second, 41 $\frac{2}{3}$ ms. For a $\frac{2}{3}$ line offset having the 1st field arrive one line early in relation to the other two fields instead of 1 line later as for the $\frac{1}{3}$ line offset should properly align the **Chroma** dot pattern diagonally. Using a 3:1 interlace at 72 Hz with 172 $\frac{2}{3}$ lines allows the use of a lower horizontal scan rate providing increased definition of the **Luma** channel and somewhat wider aspect ratio than 4:3 at 3:2. **Chroma** Rotary Phase™ will be used instead of NTSC **Chroma** since its dot matrix pattern works better with the 3:1 interlace while still offering a two frame repeat pattern but a **3.1mHz Chroma** sub-carrier frequency will be used. The vestigial sideband has been reduced by $\frac{1}{2}$ mHz to increase **Luma** bandwidth to 4 $\frac{1}{2}$ mHz. This moves the sound to **4.9mHz** having **2** separate channels of audio, **L+R & L-R**.

Optimal screen size 24" diagonal, (20"×13 $\frac{1}{3}$ "), 61cm diagonal, (50 $\frac{4}{5}$ ×33 $\frac{7}{8}$ cm), 706µm line pitch.

General:

Aspect Ratio	3:2 = 1 $\frac{1}{2}$	Good Contrast
Total Picture Pixels (Digital)	720×480 ; 345600 Pixels	177:120 = 1.475
Kell Factor (Analog Resolution)	509×340 ; 172800 Pixels	708×480 ; 339840
Maximum Digital Equiv. @-8dB	874×480 ; 419520 Pixels	500×340 ; 169920
		618×340 ; 209760

Vertical:

Frames Per Second	24 Hz
Total Lines Per Frame	518 (2 Frame CRP™ Dot Repeat)
Fields Per Second	72 Hz
Total Lines Per Field	172 $\frac{2}{3}$
Picture Lines	160
Lines Per Blank	12 $\frac{2}{3}$
Blank	1.02 ms
Sync	188 µs ; 2 $\frac{1}{3}$ Lines

With this low number of scan lines using a line doubler will increase this to 960. The ~1 $\frac{1}{2}$ mbps QAM/COFDM data stream located on the Q channel of the main carrier will then carry the high frequency Luma difference information and widen the 3:2 aspect to 1440 pixels for all 960 lines. The high resolution pixel dot clock will be 8x the Chroma frequency. The number of dot clock pixels for normal resolution of active picture area is 852. Doubling this would give 1704 and with 960 lines would provide a 16:9 aspect ratio. This data will contain mostly zeros which will be eliminated and only the sharpest edge enhancement details will be retained which should compress well using modern video data compression algorithms. It should be possible to have full resolution at the 72i/24p rate. Video digitization, decoding and frame storage must be used and this high resolution mode is best suited for a larger flat screen set of up to 60" while still providing good sharpness. If data streams are lost line line doubling will still occur but an analog style edge enhancement/acutance filter will help sharpen the edges.

Horizontal:

Resolution	Good:500 Max@-8dB:618
Lines Per Second	12.432 kHz
Period (HP)	80.438 µs (499)
Picture	71.249 µs (442) Over Scan
Total Picture Pixels	518 $\frac{3}{4}$ ≈ φ × λBW × (HP-HB) ; (500+18 $\frac{3}{4}$) ≈ 3 $\frac{5}{8}$ %
Viewable Picture Pixels/Line	500 ; 68.67 µs (426 × 2 Dot Clock)
Blank (HB)	9.188 µs (57)
Front Porch	0.967 µs (6)
Sync	3.546 µs (22)
Back Porch	4.675 µs (29)

Luma & Chroma:

Luma (λ) Bandwidth @-3dB	4 $\frac{1}{2}$ mHz ; Vestigial $\frac{3}{4}$ mHz, Corner $\frac{3}{8}$ mHz
Chroma:	Sub-Sampling 3:1:1
Sub-Carrier	3.101784 mHz
$\frac{1}{2}$ H Odd Harmonic	499 (249 $\frac{1}{2}$)
'U' Bandwidth	1 $\frac{1}{2}$ mHz (USB +1 $\frac{1}{2}$ mHz & LSB -1 $\frac{1}{2}$ mHz)
'V' Bandwidth	1 $\frac{1}{2}$ mHz (USB +1 $\frac{1}{2}$ mHz & LSB -1 $\frac{1}{2}$ mHz)
Color Burst Duration	2.579 µs ; 8 cycles 2×(2 $\frac{1}{2}$ +8+4)=29
Baseband Guard	$\frac{3}{4}$ mHz



Stereo Sound:

PM SubCarrier ±157 $\frac{1}{2}$ ° ± $\frac{7}{8}$ π ±2 $\frac{3}{4}$ R	-1.000776 mHz 80 $\frac{1}{2}$ ×H (VSB Side)
H Harmonic	4.898208 mHz
L & R Frequency Response	394
Equalization	L+R 50Hz-15kHz, L-R 100Hz-15kHz
Harmonic Peak Shifting	75µs Pre-Emphasis, Shelf at 12.73kHz (12 $\frac{1}{2}$ µs)
L-R Sub-Carrier 3×H	65µs & 650µs Phase Shift Networks (Optional)
Modulation	37.296 kHz
	Unlimited Armstrong PM ±74°, Peak Q:I=3 $\frac{1}{2}$
	Companer Controlled 'I' Channel

Standard Definition wVGA 432i72 / 432p24 w/CRP™ for a 5mHz Channel Space

Better than NTSC/PAL-M Broadcast Resolution (+35%) using $\frac{5}{8}$ U.S. Channel Space

For the vertical scan a 3:1 interlace is used at a field rate of 72 Hz to produce the Film standard 24 frames per second. For a $\frac{2}{3}$ line offset having the 1st field arrive one line early in relation to the other two fields instead of 1 line later as for the $\frac{1}{3}$ line offset should properly align the Chroma dot pattern diagonally. For the horizontal no sub-sampling will be used and the full refresh rate will also be at 24 frames per second, 41 $\frac{2}{3}$ ms. Using a 3:1 interlace at 72 Hz with 156 $\frac{2}{3}$ lines allows the use of a lower horizontal scan rate providing increased definition of the Luma channel with the Golden Aspect Ratio ϕ , 13:8. Chroma Rotary Phase™ will be used instead of NTSC Chroma since its dot matrix pattern works better with the 3:1 interlace while still offering a two frame repeat pattern but a 2 $\frac{1}{2}$ mHz Chroma sub-carrier frequency will be used. The vestigial sideband has been reduced to $\frac{3}{4}$ mHz and the Luma corner bandwidth decreased to 4mHz with cutoff at 4 $\frac{1}{4}$ mHz to fit within a 5mHz channel space. The PM sound sub-carriers are on the 'Q' channel of the main carrier. Note: # below represents a decimal.



24 " diagonal, (20 $\frac{1}{2}$ "x12 $\frac{3}{5}$ "), 61 cm diagonal, (52 x32 cm), 741 μ m line pitch.
 19 " diagonal, (16 $\frac{1}{4}$ "x10 "), 48 $\frac{1}{4}$ cm diagonal, (41 $\frac{1}{4}$ x25 $\frac{2}{5}$ cm), 588 μ m line pitch.
 15 $\frac{1}{4}$ " diagonal, (13 "x 8 "), 38 $\frac{3}{4}$ cm diagonal, (33 x20 $\frac{2}{3}$ cm), 470 μ m line pitch.
 12 $\frac{1}{5}$ " diagonal, (10 $\frac{2}{5}$ "x 6 $\frac{2}{5}$ "), 31 cm diagonal, (26 $\frac{2}{5}$ x16 $\frac{1}{4}$ cm), 376 μ m line pitch.

General:

Aspect Ratio	13:8 = 1 $\frac{5}{8}$, $\sim\phi$	Good Contrast	13:8 = 1 $\frac{5}{8}$
Total Picture Pixels (Digital)	702x432 ; 303264 Pixels		702x432 ; 303264
Kell Factor (Analog Resolution)	497x305 ; 151632 Pixels		497x305 ; 151632
Maximum Digital Equiv. @-8dB	869x432 ; 375408 Pixels		614x305 ; 187704

Vertical:

Frames Per Second	24 Hz [24.0142, +0.0592%]
Total Lines Per Frame	470 (2 Frame CRP™ Dot Repeat)
Fields Per Second	72 Hz [72.0426]
Total Lines Per Field	156 $\frac{2}{3}$
Picture Lines	144
Lines Per Blank	12 $\frac{2}{3}$
Blank	1.123 ms
Sync	207 μ s ; 2 $\frac{1}{3}$ Lines

With this low number of scan lines using a line doubler will increase this to 864. The ~1 $\frac{1}{2}$ mbs data stream located on the Q channel will then carry the high frequency Luma difference information to widen the resolution to 1404 pixels for all 864 lines. The high resolution pixel dot clock will be 8x the Chroma frequency. The number of dot clock pixels for normal resolution of active picture area is 768. Doubling this would give 1536 and with 864 lines would provide a 16:9 aspect ratio. This data will contain mostly zeros which will be eliminated and only the sharpest edge enhancement details will be retained which should compress well using modern video data compression algorithms. It should be possible to have full resolution at the 72i/24p rate. Video digitization, decoding and frame storage must be used and this high resolution mode is best suited for a larger flat screen set of up to 50" while still providing good sharpness. A lower deviation/fidelity mono sound channel will be used along with a digitized stereo, 5.1 channel surround and/or SAP mixed in with the data stream. If data streams are lost and not decodable then the analog PM mono sound with a lower fidelity will still be receiveable. Also under these conditions line doubling will still occur along with the use of a conventional edge enhancement/accutance filter to enhance Luma detail. The sound data channel should use a more robust carrier so loss is less likely using Opus as the encoding system.

Horizontal:

Resolution	Good:497 Max@-8dB:614
Lines Per Second	11.280 kHz [11.286682]
Period (HP)	88.652 μ s (443)
Picture	79.647 μ s (398) Over Scan
Total Picture Pixels	515 $\frac{1}{2}$ $\approx \phi \times \lambda BW \times (HP-HB)$; (497+18 $\frac{1}{2}$) \approx 3 $\frac{3}{5}$ %
Viewable Picture Pixels/Line	497 ; 76.845 μ s (384x2 Dot Clock)
Blank (HB)	9.005 μ s (45) [9.0]
Front Porch	1.001 μ s (5) [1.0]
Sync	3.302 μ s (16 $\frac{1}{2}$) [3.3]
Back Porch	4.703 μ s (23 $\frac{1}{2}$) [4.7]

Luma & Chroma:

Luma (λ) Bandwidth @-3dB	4 mHz ; Vestigial $\frac{3}{4}$ mHz, Corner $\frac{3}{8}$ mHz
Chroma:	Sub-Sampling 2 $\frac{2}{3}$:1:1
Sub-Carrier	2.49852 mHz [2.5]
$\frac{1}{2}$ H Odd Harmonic	443 (221 $\frac{1}{2}$)
'U' Bandwidth	1 $\frac{1}{2}$ mHz (USB +1 $\frac{1}{2}$ mHz & LSB -1 $\frac{1}{2}$ mHz)
'V' Bandwidth	1 $\frac{1}{2}$ mHz (USB +1 $\frac{1}{2}$ mHz & LSB -1 $\frac{1}{2}$ mHz)
Color Burst Duration	2.802 μ s ; 7 cycles 2x(1 $\frac{3}{4}$ +7+3)=23 $\frac{1}{2}$
Baseband Guard	$\frac{3}{4}$ mHz

Sound: Sub-Carriers on 'Q' Channel of Main Carrier. PM Deviation: $\pm\frac{7}{8}\pi$ $\pm 2\frac{3}{4}R$ $\pm 157\frac{1}{2}^\circ$
 Sub-Carrier Frequencies: L+R: 8 $\frac{1}{2}$ xH 95.88kHz [95.936795] 5 $\frac{1}{2}$ xH 62.04kHz $\pm 1R$ $\pm 57\frac{3}{4}^\circ$
 L-R: 25 $\frac{1}{2}$ xH 287.64kHz [287.810384] (50Hz-12 $\frac{1}{2}$ kHz Mono Only)
 Frequency Response 50Hz-15kHz @ -3dB (Digital Data/Sound;~20 QAM/COFDM Slots @5kHz)
 Equalization 75 μ s Pre-Emphasis, Shelf at 12.73kHz (12 $\frac{1}{2}$ μ s) (\leq 1 $\frac{1}{2}$ mbs)
 Harmonic Peak Shifting 65 μ s & 650 μ s Phase Shift Networks (Optional)

702x432
Expanded to
768 Wide
for Dot Clock

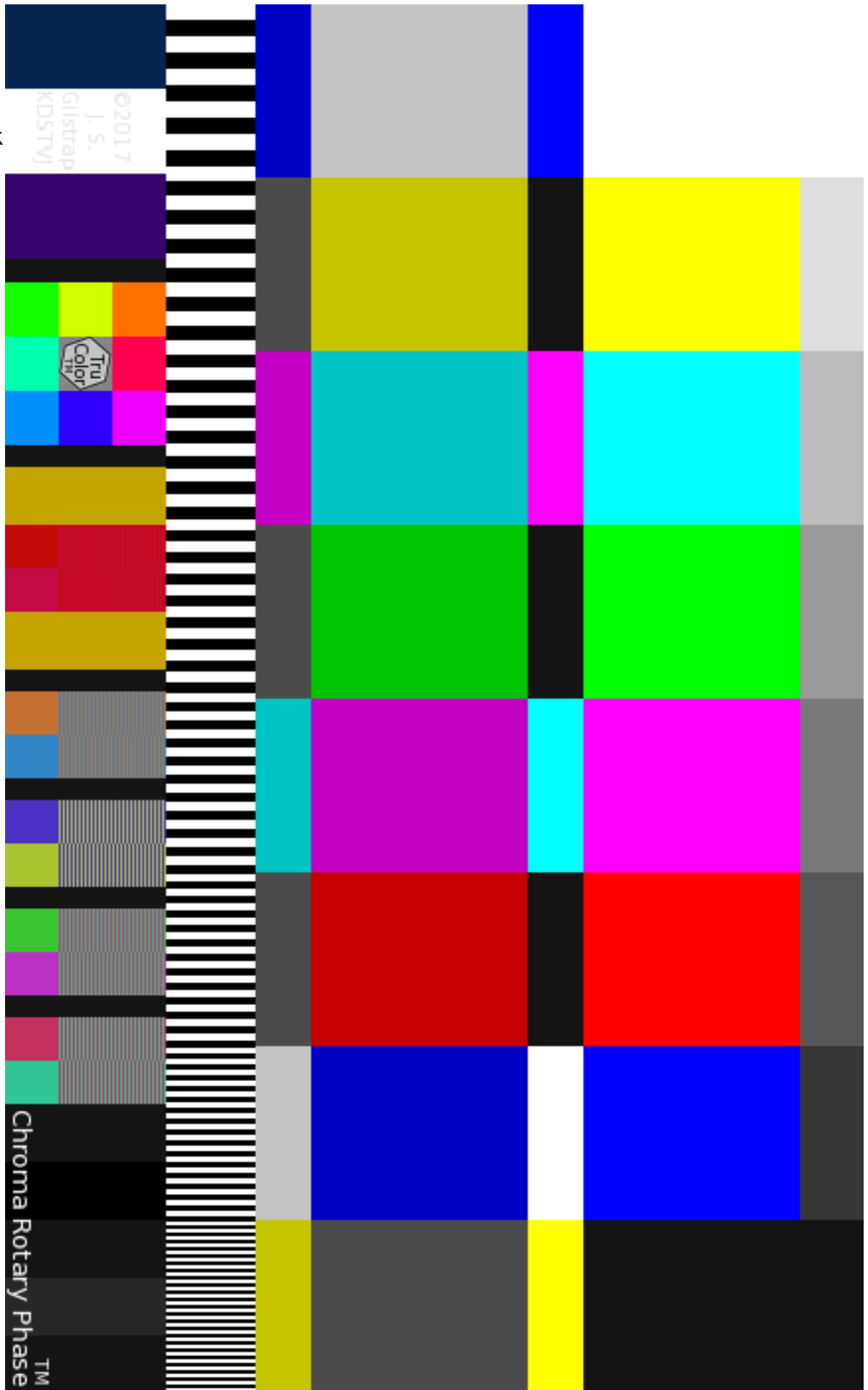

To the right is the chroma dot sequence for a 470 line format using a $\frac{2}{3}$ line offset. It shows the 2 frame repeat rate where the chroma dots are inverted on the even frames and the odd frames are non-inverted, or vice-versa, for an on screen per spot basis. The staggered vertical sync pulses cause the chroma dots to align diagonally on screen to create a uniform pattern. The dots are colored for the U & V axes where they each rotate 90° per line in opposite directions. This also causes I & Q to invert 180° every 2 lines in a flip-switch manner. In application it will be U & V that will flip-switch and I & Q will rotate 90° per line in opposite directions. The directions that I & Q rotate will depend on the U & V flip-switch order within the 4 line chroma repeat pattern. For a vestigial sideband chroma signal I & Q should rotate in the directions that optimizes I's signal integrity if there is a significant difference in quality caused by vector rotation. The diagram uses the U & V colored dots because they are easier to view. As shown in previous diagrams dot colors for composite I & Q arrangements are hard to look at.

To view the full 470 lines of chroma rotation for 2 frames zoom in on the diagram to the right. You can also highlight the image within the pdf and copy it to the clipboard and then paste it onto an image editor like The GIMP or Photoshop. The same should be done for the image on bottom of page 30 for the 526 line format with a $\frac{1}{3}$ line offset to rotate it 90° clockwise if you don't want to look at it sideways.

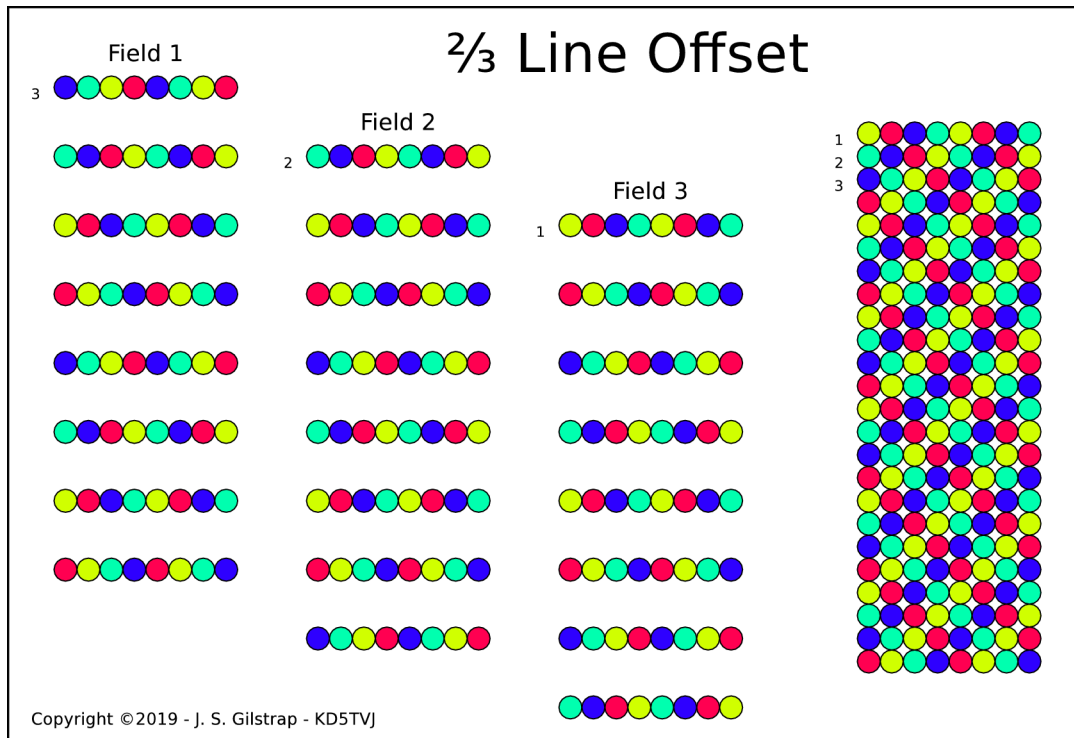

In the diagram above are the 3 fields of chroma dots separated out and also combined revealing the uniform diagonal pattern. In the left half the separated fields are vertically staggered to each other so the 4 line chroma repeat pattern is aligned between the fields. Field 1 starts with line 3 of a frame, field 2 with line 2, and field 3 with line 1. When assembled and properly staggered vertically the pattern on the right is realized.



A Minimalist NeoRetro™ Analog Color Television Standard

Standard Definition **VGA 432i72/432p24 w/CRP™** for a **4mHz** Channel Space

On Par with **NTSC/PAL-M** Broadcast Resolution (+9½%) using ⅔ U.S. Channel Space (½ EU)

For the vertical scan a 3:1 interlace is used at a field rate of 72 Hz to produce the Film standard 24 frames per second. For a ⅔ line offset having the 1st field arrive one line early in relation to the other two fields instead of 1 line later as for the ⅓ line offset should properly align the Chroma dot pattern diagonally. For the horizontal no sub-sampling will be used and the full refresh rate will also be at 24 frames per second, 41⅓ms. Using a 3:1 interlace at 72 Hz with 156⅔ lines allows the use of a lower horizontal scan rate providing increased definition of the Luma channel with a 4:3 aspect ratio. Chroma Rotary Phase™ will be used instead of NTSC Chroma since its dot matrix pattern works better with the 3:1 interlace while still offering a two frame repeat pattern but a 2mHz Chroma sub-carrier frequency will be used. The vestigial sideband has been reduced to ½mHz and the Luma corner bandwidth decreased to 3¼mHz with cutoff at 3½mHz to fit within a 4mHz channel space. The PM sound sub-carriers are on the 'Q' channel of the main carrier. ↓↓ 576×432 test pattern expanded to 618 wide for dot clock. ↓↓



24 " diagonal, (20 "×13⅓"), 61 cm diagonal, (50⅔×33⅞cm), 784µm line pitch. 3:2
 19⅞" diagonal, (16½"×11 "), 50½cm diagonal, (42 ×28 cm), 648µm line pitch. 3:2
 17 " diagonal, (13⅓"×10⅓"), 43⅓cm diagonal, (34½×25.9cm), 600µm line pitch. 4:3

General:

		Good Contrast
Aspect Ratio	4:3 = 1⅓	287:216 ≈ 1.3287
Total Picture Pixels (Digital)	576×432 ; 248832 Pixels	574×432 ; 247968
Kell Factor (Analog Resolution)	407×305 ; 124416 Pixels	406×305 ; 123984
Maximum Digital Equiv. @-8dB	709×432 ; 306288 Pixels	501×305 ; 153144
	(Test Pattern page 67) 648×432	1.0035:1 Pixel Aspect
		1.1315:1 Pixel Aspect

Vertical:

	3:2 = 1½	
Frames Per Second	24 Hz [23.9736 -0.1099%]	
Total Lines Per Frame	470 (2 Frame CRP™ Dot Repeat)	
Fields Per Second	72 Hz [71.9209]	
Total Lines Per Field	156⅔	
Picture Lines	144	
Lines Per Blank	12⅔	
Blank	1.123 ms	
Sync	207 µs ; 2⅓ Lines	

Horizontal:

	Resolution Good:406 Max@-8dB:501
Lines Per Second	11.280 kHz [11.267606]
Period (HP)	88.652 µs (355) [88⅜] (373)
Picture	79.662 µs (319) [79⅜] 79.502 (334½)
Total Picture Pixels	419 ≈ φ×λBW×(HP-HB) ; (406+13)≈3⅜% Over Scan
	418 ≈ φ×λBW×(HP-HB) ; (405+13)
Viewable Picture Pixels/Line	406 ; 77.165 µs (309×2 Dot Clock) [77⅜]
	405 ; 77.006 µs (324×2 Dot Clock)
Blank (HB)	8.990 µs (36) [9] 9.151 (38½)
Front Porch	0.999 µs (4) [1] 1.07 (4½)
Sync	3.246 µs (13) [3⅜] 3.327 (14)
Back Porch	4.745 µs (19) [4⅜] 4.754 (20)

Luma & Chroma:

Luma (λ) Bandwidth @-3dB	3¼ mHz ; Vestigial ½mHz, Corner ¼mHz
Chroma:	Sub-Sampling 2⅞:1:1
Sub-Carrier	2.0022 mHz [2] (2.10372)
½H Odd Harmonic	355 (177½) 373 (186½)
'U' Bandwidth	1⅓ mHz (USB +1⅓mHz & LSB -1⅓mHz)
'V' Bandwidth	1⅓ mHz (USB +1⅓mHz & LSB -1⅓mHz)
Color Burst Duration	2.497 µs ; 5 cycles 2×(2+5+2½)=19
Baseband Guard	½ mHz 2×(2+5+3)=20

Sound: Sub-Carrier on 'Q' Channel of Main Carrier. PM Deviation: ±⅞π ±2⅓R ±157½°

Sub-Carrier Frequency:	Mono: 8½×H 95.88kHz [95.774648]
Frequency Response	50Hz-15kHz @ -3dB (Harmonic Peak PSNs 2×1ms)
Equalization	75µs Pre-Emphasis, Shelf at 12.73kHz (12½µs)



Standard 4:3 Screen Sizes vs Dot Pitch

X	Y	Diag	X	Y	Diag	432	480	528	576
20"	15"	25"	50 ⁴ / ₅ "	38 ¹ / ₂ cm	63 ¹ / ₂ cm	882μm	794μm	722μm	662μm
19 ¹ / ₅ "	14 ² / ₅ "	24"	48 ³ / ₅ "	36 ¹ / ₂ cm	61 cm	847μm	762μm	714μm	635μm
18 ² / ₅ "	13 ⁴ / ₅ "	23"	46 ³ / ₅ "	35 cm	58 ² / ₅ cm	811μm	730μm	685μm	606μm
17 ³ / ₅ "	13 ¹ / ₅ "	22"	44 ² / ₃ "	33 ¹ / ₂ cm	55 ⁷ / ₅ cm	776μm	698μm	655μm	582μm
16 ⁴ / ₅ "	12 ³ / ₅ "	21"	42 ² / ₃ "	32 cm	53 ¹ / ₃ cm	741μm	667μm	606μm	556μm
16"	12"	20"	40 ⁵ / ₅ "	30 ¹ / ₂ cm	50 ⁴ / ₅ cm	706μm	635μm	595μm	529μm
15 ¹ / ₅ "	11 ² / ₅ "	19"	38 ³ / ₅ "	29 cm	48 ⁴ / ₅ cm	670μm	603μm	566μm	503μm
14 ² / ₅ "	10 ⁴ / ₅ "	18"	36 ³ / ₅ "	27 ² / ₅ cm	45 ⁴ / ₅ cm	635μm	572μm	536μm	476μm
13 ³ / ₅ "	10 ¹ / ₅ "	17"	34 ¹ / ₂ "	25 ⁷ / ₅ cm	43 ³ / ₅ cm	600μm	540μm	491μm	450μm
12 ⁴ / ₅ "	9 ³ / ₅ "	16"	32 ¹ / ₂ "	24 ³ / ₅ cm	40 ² / ₃ cm	564μm	506μm	476μm	423μm
12"	9"	15"	30 ¹ / ₂ "	22 ⁵ / ₅ cm	38 ¹ / ₂ cm	529μm	476μm	446μm	397μm
11 ¹ / ₅ "	8 ² / ₅ "	14"	28 ¹ / ₂ "	21 ¹ / ₃ cm	35 ¹ / ₂ cm	494μm	445μm	417μm	370μm
10 ² / ₅ "	7 ⁴ / ₅ "	13"	26 ² / ₅ "	19 ⁴ / ₅ cm	33 cm	459μm	413μm	375μm	344μm

Golden Aspect Ratio ϕ Screen Sizes vs Dot Pitch

1,2,3,5,8,13,21,34,55,89,144,233,377,610,987,1597,2584,4181,6765,10946...

$$\phi = (1+\sqrt{5})\div 2 \approx 1.618033988749895...$$

X	Y	Diag	X	Y	Diag	432	480	528	576
72"	44 ¹ / ₂ "	84 ⁵ / ₈ "	182 ⁷ / ₈ "	113cm	215 cm	2616μm	2355μm	2141μm	1962μm
56 ² / ₃ "	35"	66 ² / ₃ "	144"	89 cm	169 ¹ / ₄ cm	2060μm	1854μm	1686μm	1545μm
44 ¹ / ₂ "	27 ¹ / ₂ "	52 ¹ / ₃ "	113"	69 ⁷ / ₈ cm	132 ⁷ / ₈ cm	1617μm	1455μm	1323μm	1213μm
35"	21 ² / ₃ "	41 ¹ / ₅ "	89"	55 cm	104 ⁵ / ₈ cm	1273μm	1146μm	1042μm	955μm
27 ¹ / ₂ "	17"	32 ¹ / ₃ "	69 ⁷ / ₈ "	43 ¹ / ₆ cm	82 ¹ / ₈ cm	1000μm	900μm	818μm	750μm
21 ² / ₃ "	13 ³ / ₈ "	25 ¹ / ₂ "	55"	34 cm	64 ² / ₃ cm	787μm	708μm	644μm	590μm
17"	10 ¹ / ₂ "	20"	43 ¹ / ₆ "	26 ² / ₃ cm	50 ³ / ₄ cm	617μm	556μm	505μm	463μm
13 ³ / ₈ "	8 ¹ / ₄ "	15 ³ / ₄ "	34"	21 cm	40 cm	486μm	438μm	398μm	365μm
10 ¹ / ₂ "	6 ¹ / ₂ "	12 ³ / ₈ "	26 ² / ₃ "	16 ¹ / ₂ cm	31 ³ / ₈ cm	382μm	344μm	313μm	287μm
8 ¹ / ₄ "	5 ¹ / ₈ "	9 ³ / ₄ "	21"	13 cm	24 ² / ₃ cm	301μm	271μm	246μm	226μm

X	Y	Diag	X	Y	Diag	624	672	720	768
72"	44 ¹ / ₂ "	84 ⁵ / ₈ "	182 ⁷ / ₈ "	113cm	215 cm	1811μm	1682μm	1570μm	1472μm
56 ² / ₃ "	35"	66 ² / ₃ "	144"	89 cm	169 ¹ / ₄ cm	1426μm	1324μm	1236μm	1159μm
44 ¹ / ₂ "	27 ¹ / ₂ "	52 ¹ / ₃ "	113"	69 ⁷ / ₈ cm	132 ⁷ / ₈ cm	1119μm	1039μm	970μm	910μm
35"	21 ² / ₃ "	41 ¹ / ₅ "	89"	55 cm	104 ⁵ / ₈ cm	881μm	818μm	764μm	716μm
27 ¹ / ₂ "	17"	32 ¹ / ₃ "	69 ⁷ / ₈ "	43 ¹ / ₆ cm	82 ¹ / ₈ cm	692μm	643μm	600μm	562μm
21 ² / ₃ "	13 ³ / ₈ "	25 ¹ / ₂ "	55"	34 cm	64 ² / ₃ cm	545μm	506μm	472μm	443μm
17"	10 ¹ / ₂ "	20"	43 ¹ / ₆ "	26 ² / ₃ cm	50 ³ / ₄ cm	428μm	397μm	370μm	347μm
13 ³ / ₈ "	8 ¹ / ₄ "	15 ³ / ₄ "	34"	21 cm	40 cm	337μm	313μm	292μm	273μm
10 ¹ / ₂ "	6 ¹ / ₂ "	12 ³ / ₈ "	26 ² / ₃ "	16 ¹ / ₂ cm	31 ³ / ₈ cm	265μm	246μm	229μm	215μm
8 ¹ / ₄ "	5 ¹ / ₈ "	9 ³ / ₄ "	21"	13 cm	24 ² / ₃ cm	208μm	193μm	181μm	169μm

X	Y	Diag	X	Y	Diag	816	864	912	960
72"	44 ¹ / ₂ "	84 ⁵ / ₈ "	182 ⁷ / ₈ "	113cm	215 cm	1385μm	1308μm	1239μm	1177μm
56 ² / ₃ "	35"	66 ² / ₃ "	144"	89 cm	169 ¹ / ₄ cm	1091μm	1030μm	976μm	927μm
44 ¹ / ₂ "	27 ¹ / ₂ "	52 ¹ / ₃ "	113"	69 ⁷ / ₈ cm	132 ⁷ / ₈ cm	856μm	808μm	766μm	728μm
35"	21 ² / ₃ "	41 ¹ / ₅ "	89"	55 cm	104 ⁵ / ₈ cm	674μm	637μm	603μm	573μm
27 ¹ / ₂ "	17"	32 ¹ / ₃ "	69 ⁷ / ₈ "	43 ¹ / ₆ cm	82 ¹ / ₈ cm	529μm	500μm	473μm	450μm
21 ² / ₃ "	13 ³ / ₈ "	25 ¹ / ₂ "	55"	34 cm	64 ² / ₃ cm	417μm	394μm	373μm	354μm
17"	10 ¹ / ₂ "	20"	43 ¹ / ₆ "	26 ² / ₃ cm	50 ³ / ₄ cm	327μm	309μm	292μm	278μm
13 ³ / ₈ "	8 ¹ / ₄ "	15 ³ / ₄ "	34"	21 cm	40 cm	257μm	243μm	230μm	219μm
10 ¹ / ₂ "	6 ¹ / ₂ "	12 ³ / ₈ "	26 ² / ₃ "	16 ¹ / ₂ cm	31 ³ / ₈ cm	202μm	191μm	181μm	172μm
8 ¹ / ₄ "	5 ¹ / ₈ "	9 ³ / ₄ "	21"	13 cm	24 ² / ₃ cm	159μm	150μm	143μm	135μm

Enhanced Definition **VGA+ 528i72/528p24 w/CRP™** for a 6mHz Channel Space

Better than **NTSC/PAL-M** Broadcast Resolution (+63%) using 1 U.S. Channel Space ($\frac{3}{4}$ EU)

For the vertical scan a 3:1 interlace is used at a field rate of 72 Hz to produce the Film standard 24 frames per second. For a $\frac{2}{3}$ line offset having the 1st field arrive one line early in relation to the other two fields instead of 1 line later as for the $\frac{1}{3}$ line offset should properly align the **Chroma** dot pattern diagonally. For the horizontal no sub-sampling will be used and the full refresh rate will also be at 24 frames per second, 41 $\frac{2}{3}$ ms. Using a 3:1 interlace at 72 Hz with 192 $\frac{2}{3}$ lines allows the use of a lower horizontal scan rate providing increased definition of the **Luma** channel with a 4:3 aspect ratio. **Chroma** Rotary Phase™ will be used instead of NTSC **Chroma** since its dot matrix pattern works better with the 3:1 interlace while still offering a two frame repeat pattern but a 3.56mHz **Chroma** sub-carrier frequency will be used. The vestigial sideband has been reduced to $\frac{3}{4}$ mHz and the **Luma** corner bandwidth increased to 5mHz with cutoff at 5 $\frac{1}{4}$ mHz to fit within a 6mHz channel space. The PM sound sub-carriers are on the 'Q' channel of the main carrier. ↓↓ 704×528 test pattern expanded to 858 wide for dot clock. ↓↓



27" diagonal, (21 $\frac{3}{5}$ "×16 $\frac{1}{5}$ "), 68 $\frac{3}{5}$ cm diagonal, (54 $\frac{7}{8}$ ×41 $\frac{1}{8}$ cm), 779µm line pitch.
 22" diagonal, (17 $\frac{3}{5}$ "×13 $\frac{1}{5}$ "), 53 $\frac{1}{3}$ cm diagonal, (42 $\frac{2}{3}$ ×32 cm), 635µm line pitch.
 18" diagonal, (14 $\frac{1}{5}$ "×10 $\frac{4}{5}$ "), 43 $\frac{1}{8}$ cm diagonal, (34 $\frac{1}{2}$ ×25 $\frac{7}{8}$ cm), 520µm line pitch.
 14" diagonal, (11 $\frac{1}{5}$ "× 8 $\frac{1}{5}$ "), 35 cm diagonal, (28 ×21 cm), 404µm line pitch.

General:

Aspect Ratio	4:3 = 1 $\frac{1}{3}$	Good Contrast	345:264 = 1.307
Total Picture Pixels (Digital)	704×528 ; 371712 Pixels		690×528 ; 364320
Kell Factor (Analog Resolution)	498×373 ; 185856 Pixels		488×373 ; 182160
Maximum Digital Equiv. @-8dB	852×528 ; 449856 Pixels		603×373 ; 224928

1.0203:1 Pixel Aspect

Vertical:

Frames Per Second	24 Hz
Total Lines Per Frame	578 (2 Frame CRP™ Dot Repeat)
Fields Per Second	72 Hz
Total Lines Per Field	192 $\frac{2}{3}$
Picture Lines	176
Lines Per Blank	16 $\frac{2}{3}$
Blank	1.201 ms
Sync	192 µs ; 2 $\frac{2}{3}$ Lines

With this low number of scan lines using a line doubler will increase this to 1056. The ~1 $\frac{1}{2}$ mbps data stream located on the Q channel will then carry the high frequency Luma difference information and widen the resolution to 1408 pixels for all 1056 lines. The high resolution pixel dot clock will be 8× the Chroma frequency. The number of dot clock pixels for normal resolution of active picture area is 858. Doubling this would give 1716 and with 1056 lines would provide a 13:8 aspect ratio. This data will contain mostly zeros which will be eliminated and only the sharpest edge enhancement details will be retained which should compress well using modern video data compression algorithms. It should be possible to have full resolution at the 72i/24p rate. Video digitization, decoding and frame storage must be used and this high resolution mode is best suited for a larger flat screen set of up to 60" while still providing good sharpness. A lower deviation/fidelity mono sound channel will be used along with a digitized stereo, 5.1 channel surround and/or SAP mixed in with the data stream. If data streams are lost and not decodable then the analog PM mono sound with a lower fidelity will still be receiveable. Also under these conditions line doubling will still occur along with the use of a conventional edge enhancement/accutance filter to enhance Luma detail. The sound data channel should use a more robust carrier so loss is less likely using Opus as the encoding system.

Horizontal:

Resolution Good:	488	Max@-8dB:603
Lines Per Second	13.872 kHz	
Period (HP)	72.088 µs (513)	
Picture	62.954 µs (448)	OverScan
Total Picture Pixels	509 $\frac{2}{3}$ ≈ φ×λBW×(HP-HB) ; (487L+21L)≈4 $\frac{1}{4}$ %	
Viewable Picture Pixels/Line	487L ; 60.284 µs (429×2 Dot Clock)	
Blank (HB)	9.134 µs (65)	
Front Porch	0.984 µs (7)	
Sync	3.302 µs (23 $\frac{1}{2}$)	
Back Porch	4.707 µs (33 $\frac{1}{2}$)	

Luma & Chroma:

Luma (λ) Bandwidth @-3dB	5 mHz ; Vestigial $\frac{3}{4}$ mHz, Corner $\frac{3}{8}$ mHz
Chroma:	Sub-Sampling 27/9:1:7/9
Sub-Carrier	3.558168 mHz
$\frac{1}{2}$ H Odd Harmonic	513 (256 $\frac{1}{2}$)
Saturation Bandwidth	1 $\frac{4}{5}$ mHz (USB +1 $\frac{2}{5}$ mHz & LSB -1 $\frac{4}{5}$ mHz)
Hue Bandwidth	1 $\frac{2}{5}$ mHz (USB +1 $\frac{2}{5}$ mHz & LSB -1 $\frac{2}{5}$ mHz)
Color Burst Duration	2.529 µs ; 9 cycles 2×(3 $\frac{1}{4}$ +9+4 $\frac{1}{2}$)=33 $\frac{1}{2}$
Baseband Guard	$\frac{3}{4}$ mHz

Sound: Sub-Carriers on 'Q' Channel of Main Carrier. PM Deviation: ± $\frac{7}{8}\pi$ ±2 $\frac{3}{4}R$ ±157 $\frac{1}{2}^\circ$
 Sub-Carrier Frequencies: L+R: 7 $\frac{1}{2}$ ×H 104.040kHz 4 $\frac{1}{2}$ ×H 62.424kHz ± $\frac{1}{2}\pi$ ±1 $\frac{3}{5}R$ ±90°
 L-R: 20 $\frac{1}{2}$ ×H 284.376kHz (50Hz-12 $\frac{1}{2}$ kHz Mono Only)
 Frequency Response 50Hz-15kHz @ -3dB (Digital Data/Sound;~15 QAM/COFDM Slots @6 $\frac{7}{8}$ kHz)
 Equalization 75µs Pre-Emphasis, Shelf at 12.73kHz (12 $\frac{1}{2}$ µs)
 Harmonic Peak Shifting 65µs & 650µs Phase Shift Networks (Optional)



Wide Definition **WVGA 480i72 / 480p24 w/CRP™** for a **6mHz** Channel Space

Better than **NTSC/PAL-M** Broadcast Resolution (+68%) using 1 U.S. Channel Space.

For the vertical scan a 3:1 interlace is used at a field rate of 72 Hz to produce the Film standard 24 frames per second. For a $\frac{2}{3}$ line offset having the 1st field arrive one line early in relation to the other two fields instead of 1 line later as for the $\frac{1}{3}$ line offset should properly align the **Chroma** dot pattern diagonally. For the horizontal no sub-sampling will be used and the full refresh rate will also be at 24 frames per second, $41\frac{2}{3}$ ms. Using a 3:1 interlace at 72 Hz with $172\frac{2}{3}$ lines allows the use of a lower horizontal scan rate providing increased definition of the **Luma** channel with the **Golden Aspect Ratio** ϕ , 13:8. **Chroma** Rotary Phase™ will be used instead of NTSC **Chroma** since its dot matrix pattern works better with the 3:1 interlace while still offering a two frame repeat pattern and a **3.1mHz** **Chroma** sub-carrier frequency will be used. The vestigial sideband has been reduced to $\frac{3}{4}$ mHz and the **Luma** corner bandwidth increased to **5mHz** with cutoff at $5\frac{1}{4}$ mHz to fit within a **6mHz** channel space. The PM sound sub-carriers are on the 'Q' channel of the main carrier. Note: # below represents decimal.



30 " diagonal, ($25\frac{3}{5}$ " \times $15\frac{3}{4}$ "), 76 $\frac{1}{3}$ cm diagonal, (65 \times 40 cm), 833 μ m line pitch.
 24 " diagonal, ($20\frac{1}{2}$ " \times $12\frac{3}{5}$ "), 61 cm diagonal, (52 \times 32 cm), 667 μ m line pitch
 19 " diagonal, ($16\frac{1}{4}$ " \times 10 "), 48 $\frac{1}{2}$ cm diagonal, ($41\frac{1}{4}$ " \times $25\frac{2}{5}$ cm), 529 μ m line pitch.
 15 $\frac{3}{4}$ " diagonal, ($13\frac{3}{5}$ " \times $8\frac{1}{4}$ "), 40 cm diagonal, ($34\frac{1}{3}$ " \times 21 cm), 437 μ m line pitch.

General:

Aspect Ratio	13:8 = $1\frac{5}{8}$, $\sim\phi$	Good Contrast	131:80 = 1.6375
Total Picture Pixels (Digital)	780 \times 480 ; 374400 Pixels		786 \times 480 ; 377280
Kell Factor (Analog Resolution)	552 \times 340 ; 187200 Pixels		555 \times 340 ; 188640
Maximum Digital Equiv. @-8dB	971 \times 480 ; 466080 Pixels		687 \times 340 ; 233040

Vertical:

Frames Per Second	24 Hz
Total Lines Per Frame	518 (2 Frame CRP™ Dot Repeat)
Fields Per Second	72 Hz
Total Lines Per Field	$172\frac{2}{3}$
Picture Lines	160
Lines Per Blank	$12\frac{2}{3}$
Blank	1.02 ms
Sync	188 μ s ; $2\frac{1}{3}$ Lines

With this low number of scan lines using a line doubler will increase this to 960. The $\sim 1\frac{1}{2}$ mbps data stream located on the Q channel will then carry the high frequency Luma difference information to widen the resolution to 1560 pixels for all 960 lines. The high resolution pixel dot clock will be 8x the Chroma frequency. The number of dot clock pixels for normal resolution of active picture area is 852. Doubling this would give 1704 and with 960 lines would provide a 16:9 aspect ratio. This data will contain mostly zeros which will be eliminated and only the sharpest edge enhancement details will be retained which should compress well using modern video data compression algorithms. It should be possible to have full resolution at the 72/24p rate. Video digitization, decoding and frame storage must be used and this high resolution mode is best suited for a larger flat screen set of up to 55" while still providing good sharpness. A lower deviation/fidelity mono sound channel will be used along with a digitized stereo, 5.1 channel surround and/or SAP mixed in with the data stream. If data streams are lost and not decodable then the analog PM mono sound with a lower fidelity will still be receiveable. Also under these conditions line doubling will still occur along with the use of a conventional edge enhancement/acutance filter to enhance Luma detail. The sound data channel should use a more robust carrier so loss is less likely using Opus as the encoding system.

Horizontal:

Resolution	Good:555 $\frac{1}{2}$ Max@-8dB:687
Lines Per Second	12.432 kHz
Period (HP)	80.438 μ s (499)
Picture	71.408 μ s (443)
Total Picture Pixels	$577\frac{3}{4} \approx \phi \times \lambda BW \times (HP-HB)$; $(555\frac{1}{2} + 22\frac{1}{4}) \approx 3\frac{5}{8}\%$
Viewable Picture Pixels/Line	555 $\frac{1}{2}$; 68.67 μ s (426 \times 2 Dot Clock)
Blank (HB)	9.027 μ s (56)
Front Porch	1.048 μ s ($6\frac{1}{2}$)
Sync	3.224 μ s (20)
Back Porch	4.755 μ s (29 $\frac{1}{2}$)

Luma & Chroma:

Luma (λ) Bandwidth @-3dB	5 mHz ; Vestigial $\frac{3}{4}$ mHz, Corner $\frac{3}{8}$ mHz
Chroma:	Sub-Sampling $2\frac{2}{3}$:1:1
Sub-Carrier	3.101784 mHz
$\frac{1}{2}$ H Odd Harmonic	499 (249 $\frac{1}{2}$)
Saturation Bandwidth	$1\frac{7}{8}$ mHz (USB $+1\frac{7}{8}$ mHz & LSB $-1\frac{3}{4}$ mHz)
Hue Bandwidth	$1\frac{3}{4}$ mHz (USB $+1\frac{3}{4}$ mHz & LSB $-1\frac{3}{4}$ mHz)
Color Burst Duration	2.579 μ s ; 8 cycles $2 \times (2\frac{3}{4} + 8 + 4) = 29\frac{1}{2}$
Baseband Guard	$\frac{3}{4}$ mHz

Sound: Sub-Carriers on 'Q' Channel of Main Carrier. PM Deviation: $\pm\frac{7}{8}\pi$ $\pm 2\frac{3}{4}R$ $\pm 157\frac{1}{2}^\circ$

Sub-Carrier Frequencies: L+R:	$7\frac{1}{2} \times H$ 93.24kHz	$4\frac{1}{2} \times H$ 55.944kHz	$\pm 1 R$ $\pm 57\frac{3}{4}^\circ$
	L-R: $22\frac{1}{2} \times H$ 279.72kHz	(50Hz-12 $\frac{1}{2}$ kHz Mono Only)	
Frequency Response	50Hz-15kHz @ -3dB (Digital Data/Sound; ~ 18 QAM/COFDM Slots @6kHz)		
Equalization	75 μ s Pre-Emphasis, Shelf at 12.73kHz (12 $\frac{1}{2}$ μ s)		
Harmonic Peak Shifting	65 μ s & 650 μ s Phase Shift Networks (Optional)		

780x480

Expanded to

852 Wide
for Dot Clock

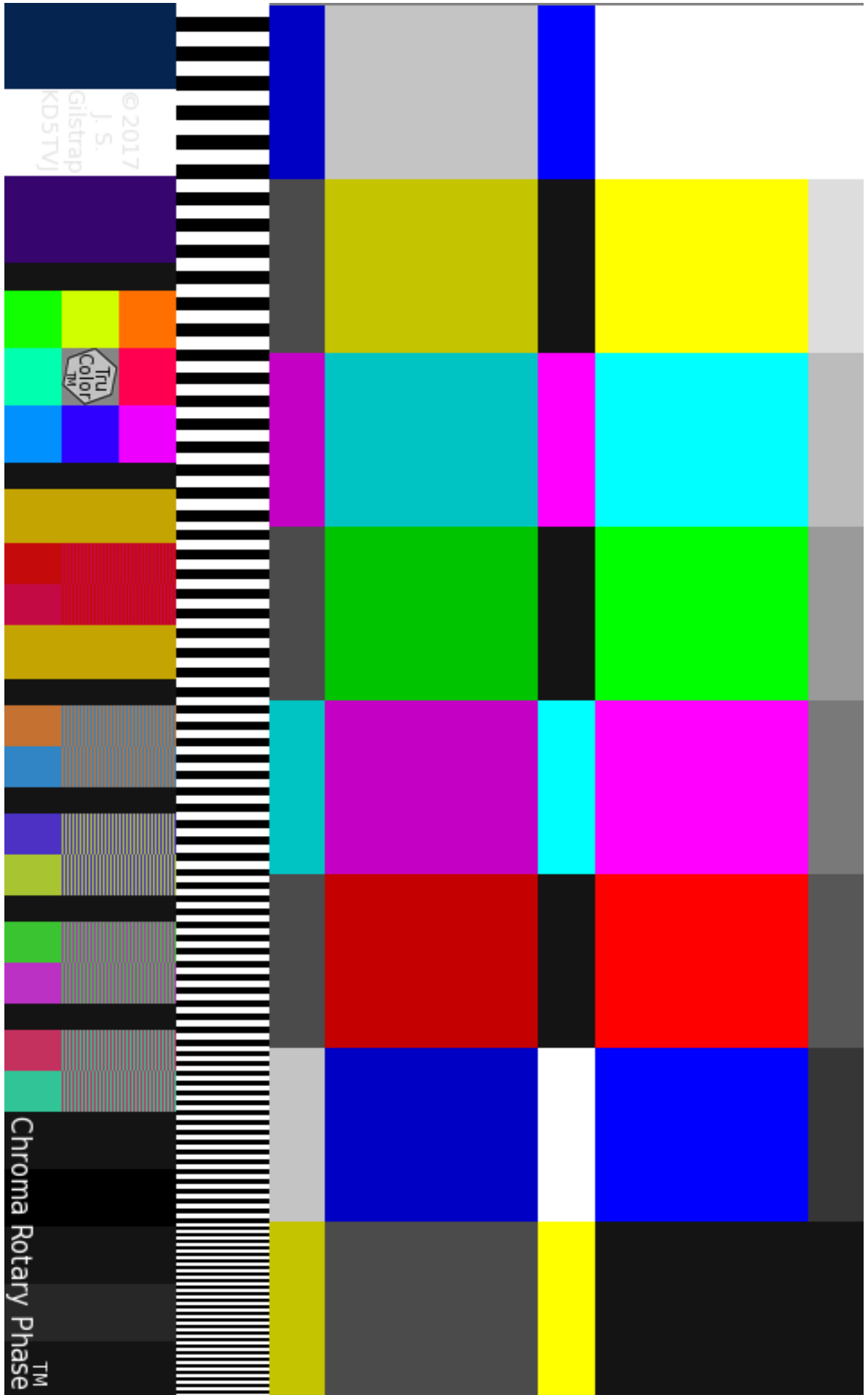

Wide Definition **WVGA 528i72 / 528p24 w/CRP™** for a 7mHz Channel Space

Better than **PAL-EU** Broadcast Resolution (+12%) using $\frac{7}{8}$ **EU** Channel Space.

For the vertical scan a 3:1 interlace is used at a field rate of 72 Hz to produce the Film standard 24 frames per second. For a $\frac{2}{3}$ line offset having the 1st field arrive one line early in relation to the other two fields instead of 1 line later as for the $\frac{1}{3}$ line offset should properly align the **Chroma** dot pattern diagonally. For the horizontal no sub-sampling will be used and the full refresh rate will also be at 24 frames per second, 41 $\frac{2}{3}$ ms. Using a 3:1 interlace at 72 Hz with 192 $\frac{2}{3}$ lines allows the use of a lower horizontal scan rate providing increased definition of the **Luma** channel with the **Golden Aspect Ratio ϕ , 13:8**. **Chroma** Rotary Phase™ will be used instead of NTSC **Chroma** since its dot matrix pattern works better with the 3:1 interlace while still offering a two frame repeat pattern and a **3.92mHz Chroma** sub-carrier frequency will be used. The vestigial sideband has been reduced to $\frac{3}{4}$ mHz and the **Luma** corner bandwidth increased to 6mHz with cutoff at 6 $\frac{1}{4}$ mHz to fit within a 7mHz channel space. The PM sound sub-carriers are on the 'Q' channel of the main carrier. Note: # below represents a decimal.



30 " diagonal, (25 $\frac{3}{5}$ "×15 $\frac{3}{4}$ "), 76 $\frac{1}{3}$ cm diagonal, (65 ×40 cm), 758 μ m line pitch.
 24 " diagonal, (20 $\frac{1}{2}$ "×12 $\frac{3}{5}$ "), 61 cm diagonal, (52 ×32 cm), 606 μ m line pitch.
 19 " diagonal, (16 $\frac{1}{4}$ "×10 "), 48 $\frac{1}{2}$ cm diagonal, (41 $\frac{1}{4}$ ×25 $\frac{2}{5}$ cm), 481 μ m line pitch.
 15 $\frac{3}{4}$ " diagonal, (13 $\frac{2}{5}$ "× 8 $\frac{1}{4}$ "), 40 cm diagonal, (34 $\frac{1}{8}$ ×21 cm), 398 μ m line pitch.

General:

Aspect Ratio	13:8 = 1 $\frac{5}{8}$, ~ ϕ	Good Contrast	823:528 = 1.5593
Total Picture Pixels (Digital)	858×528 ; 453024 Pixels		823×528 ; 434544
Kell Factor (Analog Resolution)	607×373 ; 226512 Pixels		582×373 ; 217272
Maximum Digital Equiv. @-8dB	1018×528 ; 537504 Pixels		720×373 ; 268752

Pixel Aspect 1.0421:1

Vertical:

Frames Per Second	24 Hz
Total Lines Per Frame	578 (2 Frame CRP™ Dot Repeat)
Fields Per Second	72 Hz
Total Lines Per Field	192 $\frac{2}{3}$
Picture Lines	176
Lines Per Blank	16 $\frac{2}{3}$
Blank	1.201 ms
Sync	192 μ s ; 2 $\frac{2}{3}$ Lines

With this low number of scan lines using a line doubler will increase this to 1056. The 1 $\frac{1}{2}$ mbps data stream located on the Q channel will then carry the high frequency Luma difference information and widen the resolution to 1716 pixels for all 1056 lines. The high resolution pixel dot clock will be 8x the Chroma frequency. The number of dot clock pixels for normal resolution of active picture area is 940. Doubling this would give 1880 and with 1056 lines would provide a 16:9 aspect ratio. This data will contain mostly zeros which will be eliminated and only the sharpest edge enhancement details will be retained which should compress well using modern video data compression algorithms. It should be possible to have full resolution at the 72i/24p rate. Video digitization, decoding and frame storage must be used and this high resolution mode is best suited for a larger flat screen set up of up to 64" while still providing good sharpness. A lower deviation/fidelity mono sound channel will be used along with a digitized stereo, 5.1 channel surround and/or SAP mixed in with the data stream. If data streams are lost and not decodable then the analog PM mono sound with a lower fidelity will still be receiveable. Also under these conditions line doubling will still occur along with the use of a conventional edge enhancement/accutance filter to enhance Luma detail. The sound data channel should use a more robust carrier so loss is less likely using Opus as the encoding system.

Horizontal:

Resolution Good:582 Max@-8dB:720	
Lines Per Second	13.872 kHz
Period (HP)	72.088 μ s (565)
Picture	63.029 μ s (494) OverScan
Total Picture Pixels	612 $\approx \phi \times \lambda BW \times (HP-HB)$; (582+30) $\approx 4\frac{7}{8}\%$
Viewable Picture Pixels/Line	582 ; 59.966 μ s (470×2 Dot Clock)
Blank (HB)	9.059 μ s (71)
Front Porch	1.021 μ s (8)
Sync	3.254 μ s (25 $\frac{1}{2}$)
Back Porch	4.785 μ s (37 $\frac{1}{2}$)

Luma & Chroma:

Luma (λ) Bandwidth @-3dB	6 mHz ; Vestigial $\frac{3}{4}$ mHz, Corner $\frac{3}{8}$ mHz
Chroma:	Sub-Sampling 2 $\frac{2}{5}$:1: $\frac{4}{5}$
Sub-Carrier	3.91884 mHz
$\frac{1}{2}$ H Odd Harmonic	565 (282 $\frac{1}{2}$)
Saturation Bandwidth	2 $\frac{1}{2}$ mHz (USB +2 mHz & LSB -2 $\frac{1}{2}$ mHz)
Hue Bandwidth	2 mHz (USB +2 mHz & LSB -2 mHz)
Color Burst Duration	2.55 μ s ; 10 cycles 2×(3 $\frac{1}{2}$ +10+5 $\frac{1}{4}$)=37 $\frac{1}{2}$
Baseband Guard	$\frac{3}{4}$ mHz

Sound: Sub-Carriers on 'Q' Channel of Main Carrier. PM Deviation: $\pm\frac{7}{8}\pi$ $\pm 2\frac{3}{4}R$ $\pm 157\frac{1}{2}^\circ$

Sub-Carrier Frequencies:	L+R: 7 $\frac{1}{2}$ ×H 104.040kHz	4 $\frac{1}{2}$ ×H 62.424kHz	$\pm 1R$ $\pm 573^\circ$
	L-R: 20 $\frac{1}{2}$ ×H 284.376kHz	(50Hz-12 $\frac{1}{2}$ kHz Mono Only)	
Frequency Response	50Hz-15kHz @ -3dB	(5.1 Digital; ~17 QAM/COFDM Slots @6 $\frac{1}{2}$ kHz)	
Equalization	75 μ s Pre-Emphasis, Shelf at 12.73kHz (12 $\frac{1}{2}$ μ s)		
Harmonic Peak Shifting	65 μ s & 650 μ s Phase Shift Networks (Optional)		

858x528

Expanded to
940 Wide
for Dot Clock



Standard Definition **VGA 480i72 / 480p24 w/CRP™** for a 5mHz Channel Space

Studio Quality NTSC-Film (i72/3) Better than **NTSC/PAL-M Broadcast (+35%)** using $\frac{5}{6}$ U.S. Channel Space.

For the vertical scan a 3:1 interlace is used at a field rate of 72 Hz to produce the Film standard 24 frames per second. For a $\frac{2}{3}$ line offset having the 1st field arrive one line early in relation to the other two fields instead of 1 line later as for the $\frac{1}{3}$ line offset should properly align the **Chroma** dot pattern diagonally. For the horizontal no sub-sampling will be used and the full refresh rate will also be at 24 frames per second, 41 $\frac{2}{3}$ ms. Using a 3:1 interlace at 72 Hz with 172 $\frac{2}{3}$ lines allows the use of a lower horizontal scan rate providing increased definition of the **Luma** channel with the aspect ratio of 4:3. **Chroma** Rotary Phase™ will be used instead of NTSC **Chroma** since its dot matrix pattern works better with the 3:1 interlace while still offering a two frame repeat pattern but a 2.5mHz **Chroma** sub-carrier frequency will be used. The vestigial sideband has been reduced to $\frac{3}{4}$ mHz and the **Luma** corner bandwidth decreased to 4mHz with cutoff at 4 $\frac{1}{2}$ mHz to fit within a 5mHz channel space. The PM sound sub-carriers are on the 'Q' channel of the main carrier. Note: # below represents a decimal.



25" diagonal, (20"×15"), 63 $\frac{1}{2}$ cm diagonal, (50 $\frac{4}{5}$ ×38 $\frac{1}{2}$ cm), 794µm line pitch.
 20" diagonal, (16"×12"), 50 $\frac{4}{5}$ cm diagonal, (40 $\frac{3}{8}$ ×30 $\frac{1}{2}$ cm), 635µm line pitch.
 15" diagonal, (12"× 9"), 38 $\frac{1}{2}$ cm diagonal, (30 $\frac{1}{2}$ ×22 $\frac{5}{8}$ cm), 476µm line pitch.
 10" diagonal, (8"× 6"), 25 $\frac{2}{3}$ cm diagonal, (20 $\frac{1}{3}$ ×15 $\frac{1}{4}$ cm), 318µm line pitch.

General:

Aspect Ratio	4:3 = 1 $\frac{1}{3}$	Good Contrast	21:16 = 1 $\frac{5}{16}$
Total Picture Pixels (Digital)	640×480 ; 307200 Pixels	630×480 ; 302400	
Kell Factor (Analog Resolution)	452×340 ; 153600 Pixels	446×340 ; 151200	
Maximum Digital Equiv. @-8dB	780×480 ; 374400 Pixels	551×340 ; 187200	

Vertical:

Frames Per Second	24 Hz [24.0711 +0.2962%]
Total Lines Per Frame	518 (2 Frame CRP™ Dot Repeat)
Fields Per Second	72 Hz [72.2133]
Total Lines Per Field	172 $\frac{2}{3}$
Picture Lines	160
Lines Per Blank	12 $\frac{2}{3}$
Blank	1.02 ms
Sync	188 µs ; 2 $\frac{1}{3}$ Lines

Horizontal:

Resolution	Good:446 Max@-8dB:551
Lines Per Second	12.432 kHz [12.468828]
Period (HP)	80.438 µs (401)
Picture	71.411 µs (356)
Total Picture Pixels	462 ≈ φ × λBW × (HP-HB) ; (446+16) ≈ 3 $\frac{1}{2}$ % Over Scan
Viewable Picture Pixels/Line	446 ; 68.911 µs (2×343 $\frac{1}{2}$ Dot Clock)
Blank (HB)	9.027 µs (45) [9.0]
Front Porch	0.979 µs (5) [1.0]
Sync	3.310 µs (16 $\frac{1}{2}$) [3.3]
Back Porch	4.714 µs (23 $\frac{1}{2}$) [4.7]

Luma & Chroma:

Luma (λ) Bandwidth @-3dB	4 mHz ; Vestigial $\frac{3}{4}$ mHz, Corner $\frac{3}{8}$ mHz
Chroma:	Sub-Sampling 2 $\frac{2}{3}$:1:1
Sub-Carrier	2.492616 mHz [2.5]
$\frac{1}{2}$ H Odd Harmonic	401 (200 $\frac{1}{2}$)
'U' Bandwidth	1 $\frac{1}{2}$ mHz (USB +1 $\frac{1}{2}$ mHz & LSB -1 $\frac{1}{2}$ mHz)
'V' Bandwidth	1 $\frac{1}{2}$ mHz (USB +1 $\frac{1}{2}$ mHz & LSB -1 $\frac{1}{2}$ mHz)
Color Burst Duration	2.41 µs ; 6 cycles 2×(2 $\frac{1}{4}$ +6+3 $\frac{1}{2}$)=23 $\frac{1}{2}$
Baseband Guard	$\frac{3}{4}$ mHz

Sound: Sub-Carriers on 'Q' Channel of Main Carrier. PM Deviation: ± $\frac{7}{8}\pi$ ±2 $\frac{3}{4}$ R ±157 $\frac{1}{2}$ °
 Sub-Carrier Frequencies: L+R: 7 $\frac{1}{2}$ ×H 93.24kHz 4 $\frac{1}{2}$ ×H 55.944kHz ±1R ±57 $\frac{1}{2}$ °
 L-R: 22 $\frac{1}{2}$ ×H 279.72kHz (50Hz-12 $\frac{1}{2}$ kHz Mono Only)
 Frequency Response 50Hz-15kHz @ -3dB (5.1 Digital;~18 QAM/COFDM Slots @6kHz)
 Equalization 75µs Pre-Emphasis, Shelf at 12.73kHz (12 $\frac{1}{2}$ µs)
 Harmonic Peak Shifting 65µs & 650µs Phase Shift Networks (Optional)

↓↓ 640×480 Test Pattern Expanded to 687 Wide for Dot Clock. ↓↓



©2017
J. S.
Gilstrap
(KD5TV)

Tru
Color
TM

Chroma Rotary Phase
TM

Wide Definition **WVGA 480i72 / 480p24 w/CRP™** for a **6mHz** Channel Space

Better than **NTSC/PAL-M** Broadcast Resolution (+69%) using 1 U.S. Channel Space.

For the vertical scan a 3:1 interlace is used at a field rate of 72 Hz to produce the Film standard 24 frames per second. For a $\frac{2}{3}$ line offset having the 1st field arrive one line early in relation to the other two fields instead of 1 line later as for the $\frac{1}{3}$ line offset should properly align the **Chroma** dot pattern diagonally. For the horizontal no sub-sampling will be used and the full refresh rate will also be at 24 frames per second, 41 $\frac{2}{3}$ ms. Using a 3:1 interlace at 72 Hz with 172 $\frac{2}{3}$ lines allows the use of a lower horizontal scan rate providing increased definition of the **Luma** channel with the **Golden Aspect Ratio ϕ , 13:8**.

Chroma Rotary Phase™ will be used instead of NTSC **Chroma** since its dot matrix pattern works better with the 3:1 interlace while still offering a two frame repeat pattern but a **2.83mHz Chroma** sub-carrier frequency will be used. The vestigial sideband has been reduced to $\frac{3}{4}$ mHz and the **Luma** corner bandwidth increased to 5mHz with cutoff at 5 $\frac{1}{4}$ mHz to fit within a **6mHz** channel space. The PM sound sub-carriers are on the 'Q' channel of the main carrier. Note: # below represents a decimal.



28 $\frac{5}{8}$ " diagonal, (24 $\frac{3}{8}$ "×15"), 72Zcm diagonal, (61 $\frac{9}{8}$ ×38 $\frac{1}{8}$ cm), 794 μ m line pitch.
 22 $\frac{8}{8}$ " diagonal, (19 $\frac{1}{2}$ "×12"), 58 cm diagonal, (49 $\frac{2}{5}$ ×30 $\frac{2}{5}$ cm), 634 μ m line pitch.
 19" diagonal, (16 $\frac{1}{4}$ "×10"), 48 $\frac{1}{2}$ cm diagonal, (41 $\frac{1}{4}$ ×25 $\frac{2}{5}$ cm), 529 μ m line pitch.
 15 $\frac{3}{4}$ " diagonal, (13 $\frac{2}{5}$ "× 8 $\frac{1}{4}$ "), 40 cm diagonal, (34 $\frac{1}{8}$ ×21 cm), 437 μ m line pitch.

General:

Aspect Ratio	13:8 = 1 $\frac{5}{8}$, ~ ϕ	Good Contrast
Total Picture Pixels (Digital)	780×480 ; 374400 Pixels	263:160 = 1.64375
Kell Factor (Analog Resolution)	552×340 ; 187200 Pixels	789×480 ; 378720
Maximum Digital Equiv. @-8dB	975×480 ; 468000 Pixels	558×340 ; 189360
		689×340 ; 234000

Vertical:

Frames Per Second	24 Hz
Total Lines Per Frame	518 (2 Frame CRP™ Dot Repeat)
Fields Per Second	72 Hz
Total Lines Per Field	172 $\frac{2}{3}$
Picture Lines	160
Lines Per Blank	12 $\frac{2}{3}$
Blank	1.02 ms
Sync	188 μ s ; 2 $\frac{1}{3}$ Lines

Horizontal:

Resolution	Good:558 Max@-8dB:689
Lines Per Second	12.432 kHz
Period (HP)	80.438 μ s (455)
Picture	71.421 μ s (404)
Total Picture Pixels	578 $\approx \phi \times \lambda_{BW} \times (HP-HB)$; (558+20) \approx 3 $\frac{1}{2}$ % Over Scan
Viewable Picture Pixels/Line	558 ; 68.946 μ s (390×2 Dot Clock)
Blank (HB)	9.016 μ s (51)
Front Porch	0.972 μ s (5 $\frac{1}{2}$)
Sync	3.271 μ s (18 $\frac{1}{2}$)
Back Porch	4.773 μ s (27)

Luma & Chroma:

Luma (λ) Bandwidth @-3dB	5 mHz ; Vestigial $\frac{3}{4}$ mHz, Corner $\frac{3}{8}$ mHz
Chroma:	Sub-Sampling 4 $\frac{3}{5}$:2:1 $\frac{3}{5}$
Sub-Carrier	2.82828 mHz
$\frac{1}{2}$ H Odd Harmonic	455 (227 $\frac{1}{2}$)
Saturation Bandwidth	2 $\frac{1}{6}$ mHz (USB +2 $\frac{1}{6}$ mHz & LSB -1 $\frac{3}{4}$ mHz)
Hue Bandwidth	1 $\frac{3}{4}$ mHz (USB +1 $\frac{3}{4}$ mHz & LSB -1 $\frac{3}{4}$ mHz)
Color Burst Duration	2.475 μ s ; 7 cycles 2×(2 $\frac{1}{2}$ +7+4)=27
Baseband Guard	$\frac{3}{4}$ mHz

Sound: Sub-Carriers on 'Q' Channel of Main Carrier.	PM Deviation: $\pm 7\pi$ $\pm 2\frac{3}{4}R$ $\pm 157\frac{1}{2}^\circ$
Sub-Carrier Frequencies:	L+R: 7 $\frac{1}{2}$ ×H 93.24kHz 4 $\frac{1}{2}$ ×H 55.944kHz $\pm 1R$ $\pm 57\frac{1}{2}^\circ$
	L-R: 22 $\frac{1}{2}$ ×H 279.72kHz (50Hz-12 $\frac{1}{2}$ kHz Mono Only)
Frequency Response	50Hz-15kHz @ -3dB (5.1 Digital;~18 QAM/COFDM Slots @6kHz)
Equalization	75 μ s Pre-Emphasis, Shelf at 12.73kHz (12 $\frac{1}{2}$ μ s)
Harmonic Peak Shifting	65 μ s & 650 μ s Phase Shift Networks (Optional)

780x480

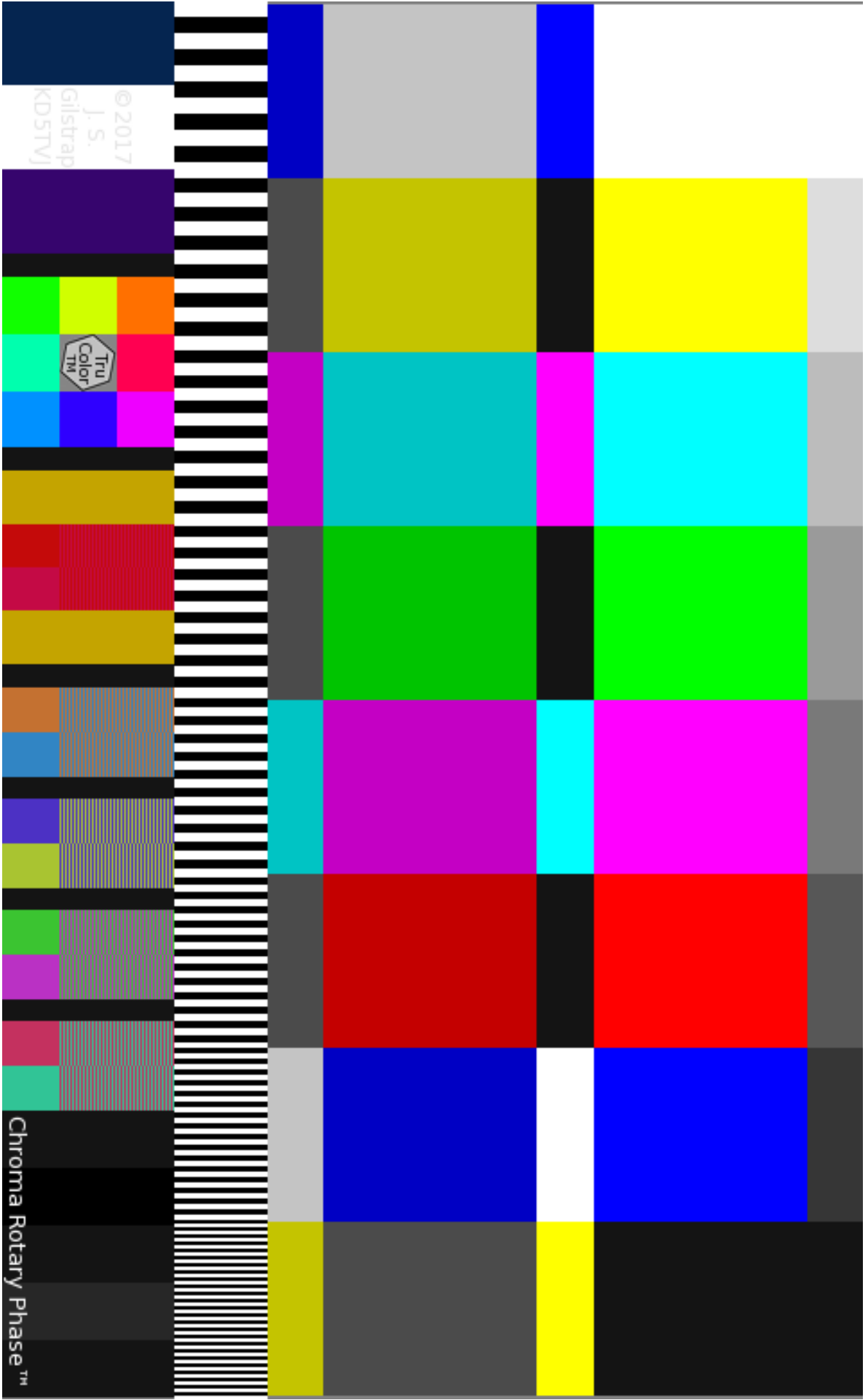

A Minimalist NeoRetro™ Analog Color Television Standard

Wider Definition **wVGA 384i72/384p24 w/CRP™** for a **4mHz** Channel Space

On Par with **NTSC/PAL-M** Broadcast Resolution using $\frac{2}{3}$ U.S. Channel Space ($\frac{1}{2}$ EU)

For the vertical scan a 3:1 interlace is used at a field rate of 72 Hz to produce the Film standard 24 frames per second. For a $\frac{2}{3}$ line offset having the 1st field arrive one line early in relation to the other two fields instead of 1 line later as for the $\frac{1}{3}$ line offset should properly align the **Chroma** dot pattern diagonally. For the horizontal no sub-sampling will be used and the full refresh rate will also be at 24 frames per second, $41\frac{2}{3}$ ms. Using a 3:1 interlace at 72 Hz with $140\frac{2}{3}$ lines allows the use of a lower horizontal scan rate providing increased definition of the **Luma** channel with a 3:2 aspect ratio. **Chroma** Rotary Phase™ will be used instead of NTSC **Chroma** since its dot matrix pattern works better with the 3:1 interlace while still offering a two frame repeat pattern but a $1\frac{2}{3}$ mHz **Chroma** sub-carrier frequency will be used. The vestigial sideband has been reduced to $\frac{3}{4}$ mHz and the **Luma** corner bandwidth decreased to **2.9mHz** with cutoff at $3\frac{1}{4}$ mHz to fit within a **4mHz** channel space. The PM sound sub-carriers are on the 'Q' channel of the main carrier. ↓↓ 576×384 test pattern. ↓↓



21 $\frac{5}{8}$ " diagonal, (18"×12"), 54 cm diagonal, (45 ×30 cm), ~788µm line pitch.
 18 " diagonal, (15"×10"), 45 $\frac{4}{5}$ cm diagonal, (38 $\frac{1}{4}$ ×25 $\frac{2}{5}$ cm), 661µm line pitch.
 14 $\frac{2}{5}$ " diagonal, (12"× 8"), 36 $\frac{5}{8}$ cm diagonal, (30 $\frac{1}{2}$ ×20 $\frac{1}{3}$ cm), 529µm line pitch.
 10 $\frac{4}{5}$ " diagonal, (9"× 6"), 27 $\frac{1}{2}$ cm diagonal, (22 $\frac{7}{8}$ ×15 $\frac{1}{4}$ cm), 397µm line pitch.

General:

Aspect Ratio	3:2 = 1 $\frac{1}{2}$	Good Contrast	3:2 = 1 $\frac{1}{2}$
Total Picture Pixels (Digital)	576×384 ; 221184 Pixels		576×384 ; 221184
Kell Factor (Analog Resolution)	407×272 ; 110592 Pixels		407×272 ; 110592
Maximum Digital Equiv. @-8dB	711×384 ; 273024 Pixels		503×272 ; 136512

Vertical:

Frames Per Second	24 Hz
Total Lines Per Frame	422 (2 Frame CRP™ Dot Repeat)
Fields Per Second	72 Hz
Total Lines Per Field	140 $\frac{2}{3}$
Picture Lines	128
Lines Per Blank	12 $\frac{2}{3}$
Blank	1.251 ms
Sync	197 µs ; 2 Lines

Horizontal:

Resolution	Good:407	Max@-8dB:503
Lines Per Second	10.128 kHz	
Period (HP)	98.736 µs (329)	
Picture	89.433 µs (298)	OverScan
Total Picture Pixels	418 ≈ $\phi \times \lambda_{BW} \times (HP - HB)$; (407+11) ≈ 2 $\frac{5}{8}$ %	
Viewable Picture Pixels/Line	407 ; 86.432 µs (288×2 Dot Clock)	
Blank (HB)	9.303 µs (31)	
Front Porch	0.900 µs (3 $\frac{1}{2}$)	
Sync	3.301 µs (11 $\frac{1}{2}$)	
Back Porch	4.802 µs (16)	

With this low number of scan lines using a line doubler will increase this to 768. The >1 mbps data stream located on the Q channel will then carry the high frequency Luma difference information to widen the resolution to 1152 pixels for all 768 lines. The high resolution pixel dot clock will be 8× the Chroma frequency. This data will contain mostly zeros which will be eliminated and only the sharpest edge enhancement details will be retained which should compress well using modern video data compression algorithms. It should be possible to have full resolution at the 72i/24p rate. Video digitization, decoding and frame storage must be used and this high resolution mode is best suited for a larger flat screen set of up to 36" while still providing good sharpness. A lower deviation/fidelity mono sound channel will be used along with a digitized stereo, 5.1 channel surround and/or SAP mixed in with the data stream. If data streams are lost and not decodable then analog PM mono sound with a lower resolution will still be received. Also under these conditions line doubling will still occur along with the use of a conventional edge enhancement/accutance filter to enhance Luma detail. The sound data channel should use a more robust carrier so loss is less likely using Opus as the encoding system.

Luma & Chroma:

Luma (λ) Bandwidth @-3dB	2.9 mHz ; Vestigial $\frac{3}{4}$ mHz, Corner $\frac{3}{8}$ mHz
Chroma:	Sub-Sampling 2 $\frac{1}{3}$:1: $\frac{2}{3}$
Sub-Carrier	1.666056 mHz
$\frac{1}{2}$ H Odd Harmonic	329 (164 $\frac{1}{2}$)
Saturation Bandwidth	1 $\frac{1}{4}$ mHz (USB +1 $\frac{1}{4}$ mHz & LSB -1 $\frac{1}{4}$ mHz)
Hue Bandwidth	$\frac{1}{2}$ mHz (USB + $\frac{1}{2}$ mHz & LSB - $\frac{1}{2}$ mHz)
Color Burst Duration	2.401 µs ; 4 cycles 2×(1 $\frac{1}{2}$ +4+2 $\frac{1}{2}$)=16
Baseband Guard	$\frac{3}{4}$ mHz

Sound: Sub-Carrier on 'Q' Channel of Main Carrier.

PM Deviation: $\pm 2\frac{3}{4}R \pm 157\frac{1}{2}^\circ \pm \frac{7}{8}\pi$

Sub-Carrier Frequency:	Mono: 9 $\frac{1}{2}$ ×H 96.216kHz	6 $\frac{1}{2}$ ×H 65.832kHz	$\pm 2 R \pm 114\frac{3}{5}^\circ$, -3dB@12 $\frac{1}{2}$ kHz
Frequency Response	50Hz-15kHz@-3dB (Digital Data/Sound ; ~22 QAM/COFDM Slots @5kHz)		
Equalization	75µs Pre-Emphasis, Shelf at 12.73kHz (12 $\frac{1}{2}$ µs) (≤1 $\frac{1}{2}$ mbps)		
Harmonic Peak Shifting	65µs & 650µs Phase Shift Networks (Optional)		

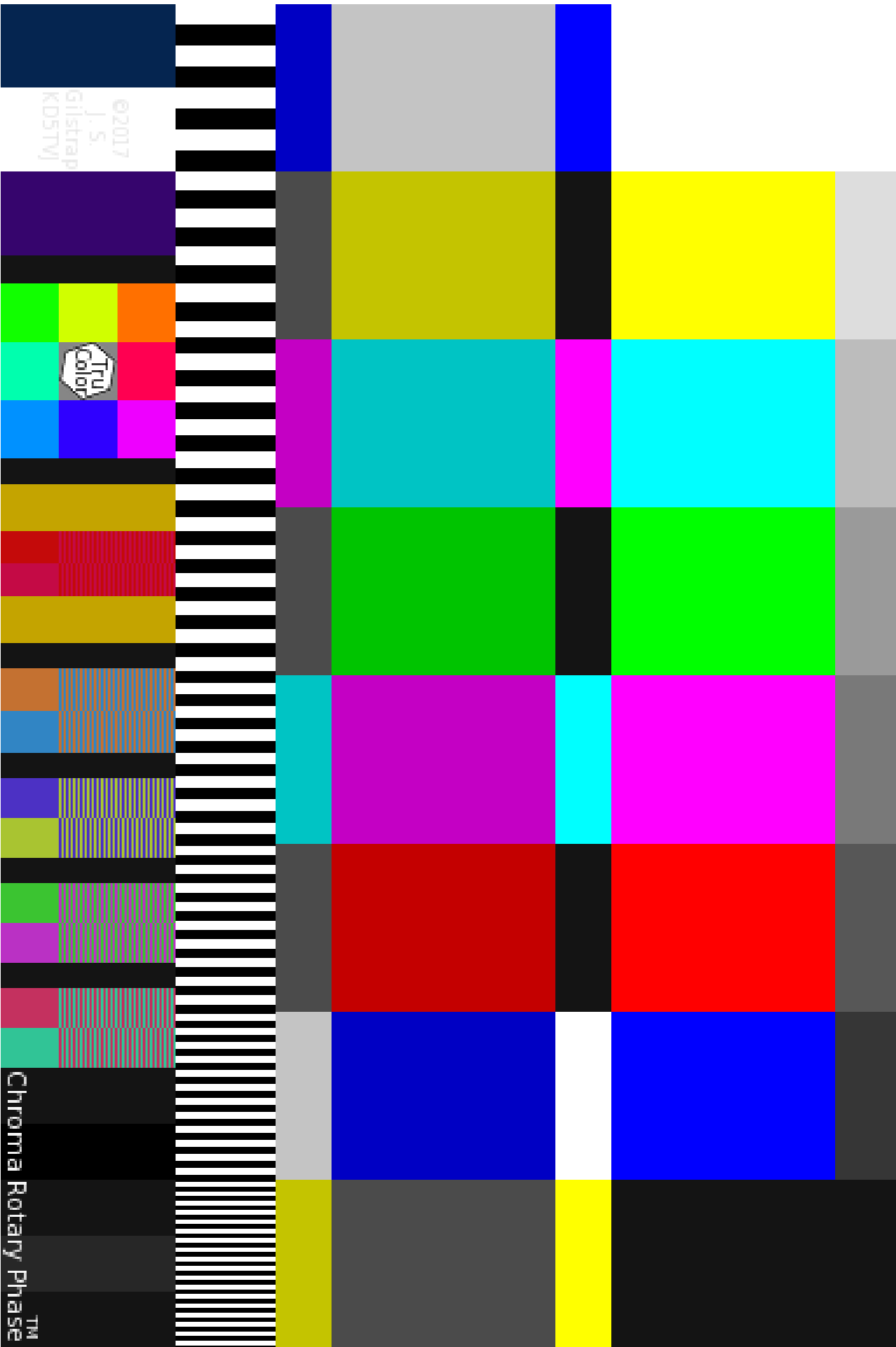

©2017
J.S.
Gilstrap
KD5TV

ITU
Color

Chroma Rotary Phase™

A Minimalist NeoRetro™ Analog Color Television Standard

Wider Definition **wVGA 432i72/432p24 w/CRP™** for a **4½mHz** Channel Space

Better than **NTSC/PAL-M** Broadcast Resolution (+22%) using **¾ U.S. Channel Space (9/16 EU)**

For the vertical scan a 3:1 interlace is used at a field rate of 72 Hz to produce the Film standard 24 frames per second. For a 2/3 line offset having the 1st field arrive one line early in relation to the other two fields instead of 1 line later as for the 1/3 line offset should properly align the Chroma dot pattern diagonally. For the horizontal no sub-sampling will be used and the full refresh rate will also be at 24 frames per second, 41 2/3ms. Using a 3:1 interlace at 72 Hz with 156 2/3 lines allows the use of a lower horizontal scan rate providing increased definition of the Luma channel with a 3:2 aspect ratio. Chroma Rotary Phase™ will be used instead of NTSC Chroma since its dot matrix pattern works better with the 3:1 interlace while still offering a two frame repeat pattern but a 2.1mHz Chroma sub-carrier frequency will be used. The vestigial sideband has been reduced to 3/4mHz and the Luma corner bandwidth decreased to 3 5/8mHz with cutoff at 3 7/8mHz to fit within a 4 1/2mHz channel space. The PM sound sub-carriers are on the 'Q' channel of the main carrier. ↓↓ 648x432 test pattern. ↓↓



24 " diagonal, (20"×13 1/3"), 61 cm diagonal, (50 4/5×33 7/8cm), 784µm line pitch.
 18 " diagonal, (15"×10 "), 45 4/5cm diagonal, (38 1/2×25 2/3cm), 588µm line pitch.
 14 2/3" diagonal, (12"× 8 "), 36 5/8cm diagonal, (30 1/2×20 1/3cm), 470µm line pitch.
 10 4/5" diagonal, (9"× 6 "), 27 1/2cm diagonal, (22 7/8×15 1/4cm), 353µm line pitch.

General:

Aspect Ratio	3:2 = 1 1/2	Good Contrast
Total Picture Pixels (Digital)	648×432 ; 279936 Pixels	213:144 ≈ 1.4792
Kell Factor (Analog Resolution)	453×305 ; 139968 Pixels	639×432 ; 276048
Maximum Digital Equiv. @-8dB	789×432 ; 340848 Pixels	452×305 ; 138024
		558×305 ; 170424
		1.014:1 Pixel Aspect

Vertical:

Frames Per Second	24 Hz
Total Lines Per Frame	470 (2 Frame CRP™ Dot Repeat)
Fields Per Second	72 Hz
Total Lines Per Field	156 2/3
Picture Lines	144
Lines Per Blank	12 2/3
Blank	1.123 ms
Sync	207 µs ; 2 1/3 Lines

With this low number of scan lines using a line doubler will increase this to 864. The >1 mbps data stream located on the Q channel will then carry the high frequency Luma difference information to widen the resolution to 1296 pixels for all 864 lines. The high resolution pixel dot clock will be 8x the Chroma frequency. This data will contain mostly zeros which will be eliminated and only the sharpest edge enhancement details will be retained which should compress well using modern video data compression algorithms. It should be possible to have full resolution at the 72i/24p rate. Video digitization, decoding and frame storage must be used and this high resolution mode is best suited for a larger flat screen set of up to 50" while still providing good sharpness. A lower deviation/fidelity mono sound channel will be used along with a digitized stereo, 5.1 channel surround and/or SAP mixed in with the data stream. If data streams are lost and not decodable then analog PM mono sound with a lower resolution will still be received. Also under these conditions line doubling will still occur along with the use of a conventional edge enhancement/accutance filter to enhance Luma detail. The sound data channel should use a more robust carrier so loss is less likely using Opus as the encoding system.

Horizontal:

Resolution	Good:452 Max@-8dB:558
Lines Per Second	11.28 kHz
Period (HP)	88.652 µs (373)
Picture	79.502 µs (334 1/2) OverScan
Total Picture Pixels	466 ≈ φ×λBW×(HP-HB) ; (452+14)≈3%
Viewable Picture Pixels/Line	452 ; 77.006 µs (324×2 Dot Clock)
Blank (HB)	9.151 µs (38 1/2)
Front Porch	1.07 µs (4 1/2)
Sync	3.327 µs (14)
Back Porch	4.754 µs (20)

Luma & Chroma:

Luma (λ) Bandwidth @-3dB	3 5/8 mHz ; Vestigial 5/8mHz, Corner 1/3mHz
Chroma:	Sub-Sampling 2 2/3:1:2/3
Sub-Carrier	2.10372 mHz
1/2H Odd Harmonic	373 (186 1/2)
Saturation Bandwidth	1 1/2 mHz (USB +1 1/2mHz & LSB -1mHz)
Hue Bandwidth	1 mHz (USB +1 mHz & LSB -1mHz)
Color Burst Duration	2.376 µs ; 5 cycles 2×(2+5+3)=20
Baseband Guard	5/8 mHz

Sound: Sub-Carrier on 'Q' Channel of Main Carrier.

PM Deviation: ±2 3/4R ±157 1/2° ±7/8π

Sub-Carrier Frequency:	Mono: 8 1/2×H 95.88kHz 6 1/2×H 73.32kHz ±2 R ±114 3/5°, -3dB@12 1/2kHz
Frequency Response	50Hz-15kHz@-3dB (Digital Data/Sound; ~18 QAM/COFDM Slots @5 1/2kHz)
Equalization	75µs Pre-Emphasis, Shelf at 12.73kHz (12 1/2µs) (≤1 1/2mbps)
Harmonic Peak Shifting	65µs & 650µs Phase Shift Networks (Optional)



©2017
J. S.
Gilstrap
KD5TVJ



Chroma Rotary PhaseTM